

MC75A Enterprise Digital Assistant

User Guide

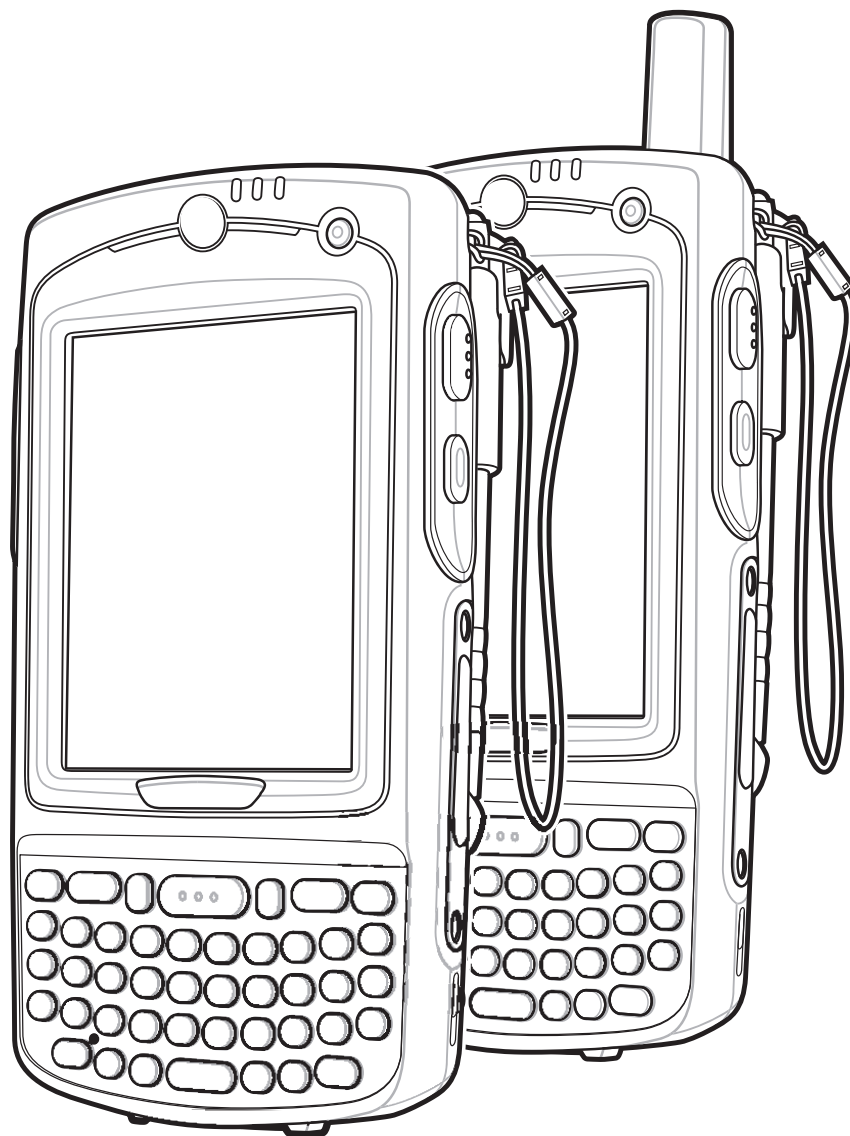

***MC75A Enterprise Digital Assistant
User Guide***

72E-133503-02

Rev. A

April 2015

© 2015 ZIH Corp

No part of this publication may be reproduced or used in any form, or by any electrical or mechanical means, without permission in writing from Zebra. This includes electronic or mechanical means, such as photocopying, recording, or information storage and retrieval systems. The material in this manual is subject to change without notice.

The software is provided strictly on an “as is” basis. All software, including firmware, furnished to the user is on a licensed basis. Zebra grants to the user a non-transferable and non-exclusive license to use each software or firmware program delivered hereunder (licensed program). Except as noted below, such license may not be assigned, sublicensed, or otherwise transferred by the user without prior written consent of Zebra. No right to copy a licensed program in whole or in part is granted, except as permitted under copyright law. The user shall not modify, merge, or incorporate any form or portion of a licensed program with other program material, create a derivative work from a licensed program, or use a licensed program in a network without written permission from Zebra. The user agrees to maintain Zebra’s copyright notice on the licensed programs delivered hereunder, and to include the same on any authorized copies it makes, in whole or in part. The user agrees not to decompile, disassemble, decode, or reverse engineer any licensed program delivered to the user or any portion thereof.

Zebra reserves the right to make changes to any software or product to improve reliability, function, or design.

Zebra does not assume any product liability arising out of, or in connection with, the application or use of any product, circuit, or application described herein.

No license is granted, either expressly or by implication, estoppel, or otherwise under any Zebra, intellectual property rights. An implied license only exists for equipment, circuits, and subsystems contained in Zebra products.

Revision History

Changes to the original manual are listed below:

Change	Date	Description
-01 Rev. A	03/2010	Initial release.
-02 Rev. A	04/2015	Zebra rebranding.

Table of Contents

Revision History	iii
------------------------	-----

About This Guide

Introduction	xi
Documentation Set	xi
Configurations	xii
Software Versions	xii
Chapter Descriptions	xv
Notational Conventions	xv
Related Documents	xvi
Service Information	xvi

Chapter 1: Getting Started

Introduction	1-1
Unpacking	1-2
Getting Started	1-2
Installing the SIM Card	1-3
Installing the Main Battery	1-4
Charging the Battery	1-5
Charging the Main Battery and Memory Backup Battery	1-5
Charging Spare Batteries	1-7
Charging Temperature	1-7
Powering On the MC75A	1-7
Calibrating the Screen	1-7
Checking Battery Status	1-8
Micro Secure Digital (microSD) Card	1-8
Adjusting the Handstrap	1-9
Replacing the Main Battery	1-9
Changing the Power Settings	1-11
Changing the Backlight Settings	1-11
Changing the Keypad Backlight Settings	1-11
Turning Off the Radios	1-12

Chapter 2: Using the MC75A

Introduction	2-1
Home Screen	2-1
Status Bar	2-2
Today Screen	2-4
Classic Today Screen	2-5
Soft Keys Bar	2-6
Start Screen	2-7
Adjusting Volume	2-12
Battery Status Indications	2-13
Battery Reserve Options	2-13
Main Battery Temperature Notifications	2-14
LED Indicators	2-15
Resetting the MC75A	2-17
Performing a Warm Boot	2-17
Performing a Cold Boot	2-17
Waking the MC75A	2-18
Locking the MC75A	2-18
Password Locking	2-19
Function Buttons	2-20
Stylus	2-21
Entering Data	2-22
Power Management	2-23
Display Orientation	2-23
Free Fall Detection	2-24
Taking Photos	2-24
Recording Video	2-24
Viewing Photos and Videos	2-25
Using IrDA	2-25
Infrared Connection	2-26
Exchanging Files using IR Connection	2-26

Chapter 3: Data Capture

Introduction	3-1
Laser Scanning	3-1
Scanning Considerations	3-1
Bar Code Scanning	3-2
Imaging	3-2
Operational Modes	3-3
Imager Scanning	3-3
Color Digital Camera	3-4
Digital Camera Scanning	3-4

Chapter 4: Using the Phone

Introduction	4-1
Accessing the Phone Keypad	4-1
Turning the Phone On and Off	4-2
Using a Wired Headset	4-3
Using a Bluetooth Headset	4-4

Adjusting Audio Volume	4-4
Making a Call	4-5
Using the Phone Dialer	4-5
Using Contacts	4-5
Using Call History	4-6
Making a Speed Dial Call	4-6
Making an Emergency Call	4-7
Answering a Call	4-7
Incoming Call Features	4-8
Smart Dialing	4-8
Muting a Call	4-9
Taking Notes	4-10
Using Speed Dial	4-11
Adding a Speed Dial Entry	4-11
Editing a Speed Dial Entry	4-13
Deleting a Speed Dial Entry	4-13
Using Call History	4-14
Managing Call History	4-14
Changing the Call History View	4-14
Resetting the Recent Calls Counter	4-14
Deleting All Call History Items	4-15
Viewing Call Status	4-16
Using the Call History Menu	4-17
Swapping Calls on an MC75A6	4-17
Swapping Calls on an MC75A8	4-18
Conference Calling on an MC75A6	4-19
Three-way Calling on an MC75A8	4-21
Text Messaging	4-21
Viewing Text Messages	4-21
Sending a Text Message	4-23
Using a Dual Line SIM	4-24

Chapter 5: Using GPS Navigation

Introduction	5-1
Software Installation	5-1
MC75A GPS Setup	5-1
Operation	5-2
GPS Maps on microSD Cards	5-2
Answering a Phone Call While Using GPS	5-2
Losing the GPS Signal While in a Vehicle	5-2
Assisted GPS	5-2

Chapter 6: Using Bluetooth

Introduction	6-1
Adaptive Frequency Hopping	6-1
Security	6-2
Bluetooth Power States	6-3
Cold Boot	6-3
Warm Boot	6-4

Suspend	6-4
Resume	6-4
Using Microsoft Bluetooth Stack	6-4
Turning the Bluetooth Radio Mode On and Off	6-4
Enabling Bluetooth	6-4
Disabling Bluetooth	6-5
Discovering Bluetooth Device(s)	6-5
Available Services	6-8
Object Push Services via Beam	6-8
Internet Sharing	6-9
Hands-free Services	6-10
Serial Port Services	6-11
ActiveSync Using Serial Port Services	6-12
Phone Book Access Profile Services	6-13
Dial-Up Networking Services	6-14
Connect to a HID Device	6-14
A2DP/AVRCP Services	6-14
Turning the Bluetooth Radio Mode On and Off	6-16
Disabling Bluetooth	6-16
Enabling Bluetooth	6-16
Modes	6-16
Wizard Mode	6-16
Explorer Mode	6-16
Discovering Bluetooth Device(s)	6-17
Available Services	6-20
File Transfer Services	6-20
Connecting to the Internet Using an Access Point	6-22
Dial-Up Networking Services	6-22
Object Exchange Push Services	6-23
Headset Services	6-27
Hands-free Services	6-28
Serial Port Services	6-28
ActiveSync Using Serial Port Services	6-29
Personal Area Network Services	6-30
IrMC Synchronization Services	6-30
A2DP/AVRCP Services	6-30
Connect to a HID Device	6-31
Bonding with Discovered Device(s)	6-32
Bluetooth Settings	6-34
Device Info Tab	6-34
Services Tab	6-34
Security Tab	6-42
Discovery Tab	6-43
Virtual COM Port Tab	6-43
HID Tab	6-44
Profiles Tab	6-45
System Parameters Tab	6-46
Miscellaneous Tab	6-46

Chapter 7: Accessories

Introduction	7-1
Single Slot USB/Serial Cradle	7-3
Charging the MC75A Battery	7-3
Charging the Spare Battery	7-4
Battery Charging Indicators	7-4
Charging Temperature	7-4
Charging	7-5
Battery Charging Indicators	7-5
Charging Temperature	7-6
Charging	7-7
Battery Charging Indicators	7-7
Charging Temperature	7-7
Charging the MC75A Battery	7-9
Removing the MC75A	7-10
Charging the Spare Battery	7-10
Battery Charging Indicators	7-11
Charging Temperature	7-11
MC75A Battery Shim Installation	7-12
Spare Battery Charging	7-12
Battery Charging Indicators	7-13
Charging Temperature	7-13
Attaching and Removing the MSR	7-14
Using the MSR	7-14
Getting Started	7-16
Installation	7-16
Removal	7-16
Credit Card Transactions	7-17
Debit Card Transactions	7-17
Keypad	7-18
Display Messages	7-19
Check the DCR Battery Level	7-19
Installation	7-21
Removal	7-21
Credit Card Transactions	7-22
Debit Card Transactions	7-22
Chip and PIN Transactions	7-23
Keypad	7-23
Display Messages	7-24
Battery Charging and Operating Power	7-27
LED Charge Indications	7-28
Charging Temperature	7-28

Chapter 8: Maintenance & Troubleshooting

Introduction	8-1
Maintaining the MC75A	8-1
Removing the Screen Protector	8-2
Battery Safety Guidelines	8-2
Cleaning	8-3

Materials Required	8-3
Cleaning the MC75A	8-3
Housing	8-3
Display	8-4
Scanner Exit Window	8-4
Connector	8-4
Cleaning Cradle Connectors	8-4
Cleaning Frequency	8-5
Troubleshooting	8-5
MC75A	8-5
Bluetooth Connection	8-7
Single Slot USB/Serial Cradle	8-8
Four Slot Ethernet Cradle	8-10
Vehicle Cradle	8-10
Four Slot Battery Charger	8-11
Cables	8-12
Magnetic Stripe Reader	8-12

Appendix A: Technical Specifications

MC75A Technical Specifications	A-1
MC75A	A-1
Single Slot USB/Serial Cradle	A-6
Four Slot Ethernet Cradle	A-6
Four Slot Charge Only Cradle	A-7
Four Slot Battery Charger	A-7
Magnetic Stripe Reader	A-8

Appendix B: Keypads

Introduction	B-1
Numeric Keypad Configuration	B-1
DSD Keypad Configuration	B-5
Alpha-numeric Keypad Configurations	B-8
Special Character Key	B-15

Appendix C: Voice Quality Manager

Introduction	C-1
Features	C-1
Enabling VQM	C-1
Audio Modes	C-2
Changing Audio Modes	C-2
Voice Packet Prioritization	C-3
Acoustic Echo Cancellation	C-4
Limitations	C-4
Disabling VQM	C-4

Glossary

Index

About This Guide

Introduction

This guide provides information about using the MC75A Enterprise Digital Assistant (EDA) and accessories.

✓ **NOTE** Screens and windows pictured in this guide are samples and can differ from actual screens.

Documentation Set

The documentation set for the MC75A provides information for specific user needs, and includes:

- **MC75A Quick Start Guide** - describes how to get the MC75A EDA up and running.
- **MC75A Enterprise Digital Assistant User Guide** - describes how to use the MC75A EDA.
- **MC75A Enterprise Digital Assistant Integrator Guide** - describes how to set up the MC75A EDA and accessories.
- **Microsoft® Windows Mobile 6.0 Applications User Guide** - describes how to use Microsoft developed applications.
- **Application Guide** - describes how to use Enterprise Mobility developed sample applications.
- **Enterprise Mobility Developer Kit (EMDK) Help File** - provides API information for writing applications.

Configurations

This guide covers the following configurations:

Configuration	Radios	Display	Memory	Data Capture	Operating System	Keypads
MC75A0	WPAN: Bluetooth WLAN: 802.11a/b/g	3.5" VGA Color	256 MB RAM/ 1 GB Flash	1D laser scanner, 2D imager or camera	Windows Mobile 6.5 Classic	Numeric QWERTY, AZERTY or QWERTZ keypads
MC75A6	WPAN: Bluetooth WLAN: 802.11a/b/g WWAN: HSDPA GPS: SiRF III	3.5" VGA Color	256 MB RAM/ 1 GB Flash	1D laser scanner, 2D imager or camera	Windows Mobile 6.5 Professional	Numeric, DSD or QWERTY, AZERTY or QWERTZ keypads
MC75A8	WPAN: Bluetooth WLAN: 802.11a/b/g WWAN: EVDO GPS: SiRF III	3.5" VGA Color	256 MB RAM/ 1 GB Flash	1D laser scanner, 2D imager or camera	Windows Mobile 6.5 Professional	Numeric, DSD or QWERTY, AZERTY or QWERTZ keypads

Software Versions

This guide covers various software configurations and references are made to operating system or software versions for:

- Adaptation Kit Update (AKU) version
- OEM version
- Phone version
- BTExplorer version
- Fusion version
- Phone version.

AKU Version

To determine the Adaptation Kit Update (AKU) version:

Tap **Start** > **Settings** > **System** folder > **About** icon > **Version** tab.

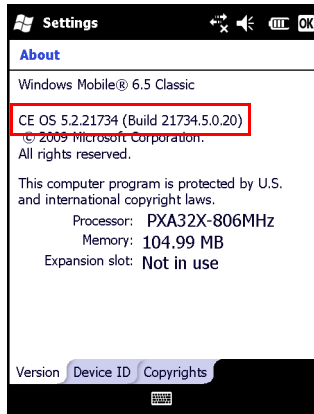

The second line lists the operating system version and the build number. The last part of the build number represents the AKU number. For example, *Build 18552.0.7.5* indicates that the device is running AKU version *0.7.5*.

OEM Version

To determine the OEM software version:

Tap **Start > Settings > System folder > System Info icon > System tab**.

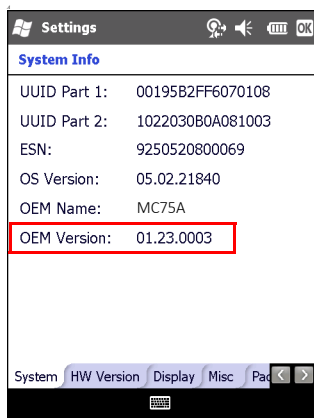

BTEplorer Software

✓ **NOTE** To view the BTEplorer version information, the StoneStreet One Bluetooth stack must be enabled. Refer to the *MC75A Enterprise Digital Assistant Integrator Guide* for more information.

To determine the BTEplorer software version:

Tap **Start > BTEplorer icon > Show BTEplorer> Menu > About**.



Fusion Software

To determine the Fusion software version:

Tap **Start > Wireless Companion icon > Wireless Status icon > Versions**.

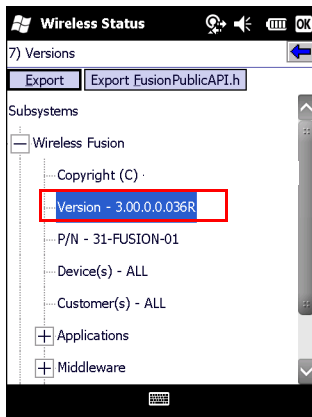

Phone Software

To determine the Phone software version:

Tap **Start > Phone > Menu > Options > Phone Info or Version Information tab**.

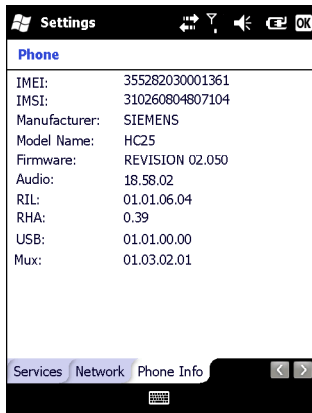

MC75A6



MC75A8

Chapter Descriptions

Topics covered in this guide are as follows:

- [Chapter 1, Getting Started](#) provides information on getting the MC75A up and running for the first time.
- [Chapter 2, Using the MC75A](#) provides basic instructions for using the MC75A, including powering on and resetting the MC75A, and entering and capturing data.
- [Chapter 3, Data Capture](#) provides information for using the MC75A to capture data using the laser scanner, imager or camera.
- [Chapter 4, Using the Phone](#) provides basic instructions for using the MC75A phone.
- [Chapter 5, Using GPS Navigation](#) provides information about GPS navigation with the MC75A.
- [Chapter 6, Using Bluetooth](#) explains Bluetooth functionality on the MC75A.
- [Chapter 7, Accessories](#) describes the available accessories and how to use them with the MC75A.
- [Chapter 8, Maintenance & Troubleshooting](#) includes instructions on cleaning and storing the MC75A, and provides troubleshooting solutions for potential problems during MC75A operation.
- [Appendix A, Technical Specifications](#) provides the technical specifications for the MC75A.
- [Appendix B, Keypads](#) provides keypad layouts and operation.
- [Appendix C, Voice Quality Manager](#) provides information on using the Voice Quality Manager software.

Notational Conventions

The following conventions are used in this document:

- “EDA” refers to the Zebra MC75A series of mobile computers.
- *Italics* are used to highlight the following:
 - Chapters and sections in this and related documents
 - Icons on a screen.
- **Bold** text is used to highlight the following:
 - Dialog box, window, and screen names
 - Drop-down list and list box names
 - Check box and radio button names
 - Key names on a keypad
 - Button names on a screen.
- Bullets (•) indicate:
 - Action items
 - Lists of alternatives
 - Lists of required steps that are not necessarily sequential
- Sequential lists (e.g., those that describe step-by-step procedures) appear as numbered lists.

Related Documents

- *MC75A Quick Start Guide*, p/n 72-127677-xx.
- *MC75A Windows Mobile 6 Regulatory Guide*, p/n 72-130201-xx.
- *MC75A Enterprise Digital Assistant Integrator Guide*, p/n 72E-133624-xx.
- *Microsoft® Applications for Mobile 6 User Guide*, p/n 72E-108299-xx
- *Application Guide*, p/n 72E-68901-xx
- *Enterprise Mobility Developer Kits (EMDKs)*, available at: <http://www.zebra.com/support>.
- Latest ActiveSync software, available at: <http://www.microsoft.com>.

For the latest version of this guide and all guides, go to: <http://www.zebra.com/support>.

Service Information

If you have a problem with your equipment, contact Zebra support for your region. Contact information is available at: <http://www.zebra.com/support>.

When contacting support, please have the following information available:

- Serial number of the unit
- Model number or product name
- Software type and version number

Zebra responds to calls by email, telephone or fax within the time limits set forth in support agreements.

If your problem cannot be solved by Zebra Support, you may need to return your equipment for servicing and will be given specific directions. Zebra is not responsible for any damages incurred during shipment if the approved shipping container is not used. Shipping the units improperly can possibly void the warranty.

If you purchased your business product from a Zebra business partner, contact that business partner for support.

Chapter 1 Getting Started

Introduction

This chapter lists the parts and accessories for the MC75A and explains how to install and charge the batteries, replace the strap, and power on the MC75A for the first time.

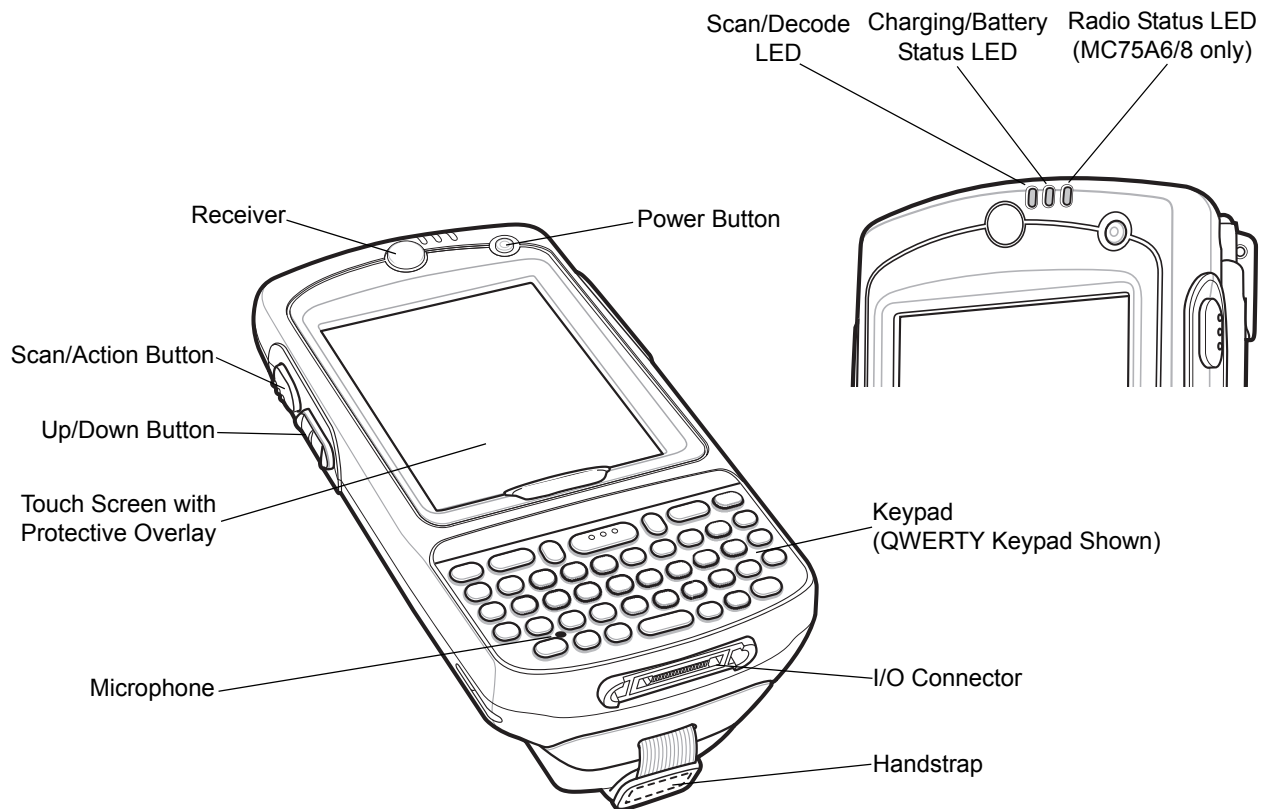

Figure 1-1 MC75A Front View

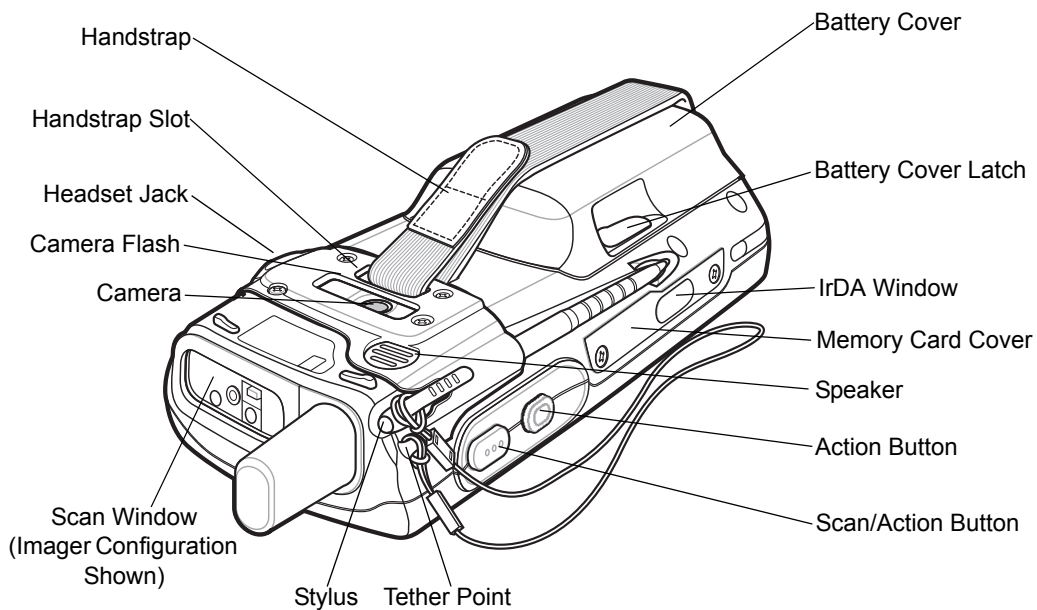

Figure 1-2 MC75A Rear View

Unpacking

Carefully remove all protective material from the MC75A and save the shipping container for later storage and shipping.

Verify that you received the following:

- MC75A EDA
- Lithium-ion battery
- Battery cover/strap assembly
- Tethered stylus
- Protective overlay, installed on display window
- Regulatory Guide
- Quick Start Guide.

Inspect the equipment for damage. If any equipment is missing or damaged, contact the Zebra Enterprise Mobility Support center immediately. See [page xvi](#) for contact information.

Getting Started

To start using the MC75A for the first time:

- Install the SIM card (MC75A6 only)
- Install the main battery.
- Charge the MC75A.

- Power on the MC75A.
- Configure the MC75A.

Installing the SIM Card

✓ **NOTE** MC75A6 configurations only.

GSM phone service requires a Subscriber Identification Module (SIM) card, or smart card. Obtain this card from the your service provider. The card fits into the MC75A and can contain the following information:

- Mobile phone service provider account details.
- Information regarding service access and preferences.
- Contact information, which can be moved to **Contacts** on the MC75A.
- Any additional services to which you have subscribed.

✓ **NOTE** For more information about SIM cards, refer to the service provider's documentation.

To install the SIM card:

1. Slide the SIM cover to unlock.
2. Lift the SIM cover using the stylus tip.

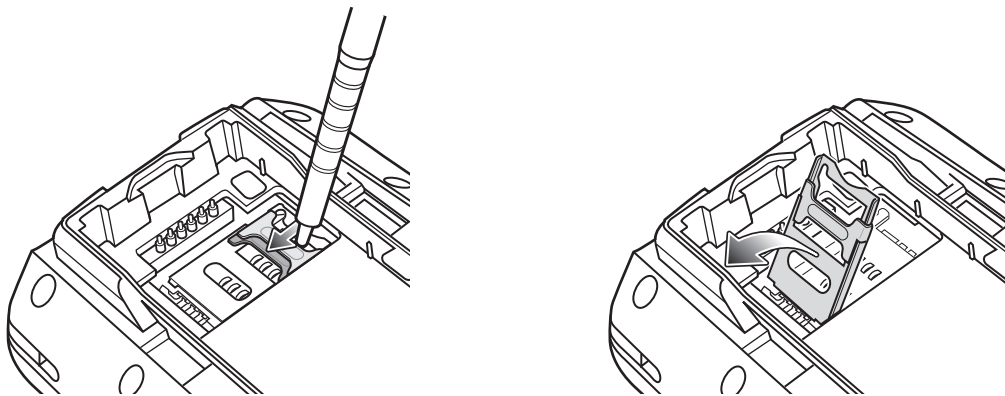

Figure 1-3 *Lifting the SIM Cover*

3. Insert the SIM card, as shown in [Figure 1-4](#), with the cut edge of the card facing out and the contacts facing down.

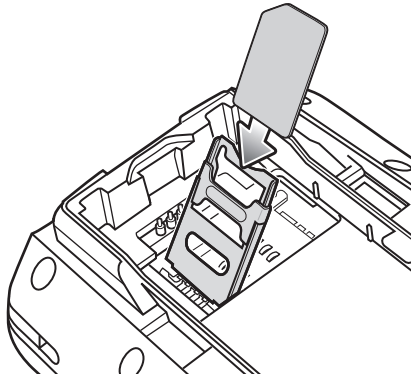

Figure 1-4 *Inserting the SIM Card*

4. Lower the SIM cover and using the stylus tip, slide it in place.
5. Install the battery. See [Installing the Main Battery on page 1-4](#) for more information.
6. After completing initial MC75A setup or after replacing a SIM card:
 - a. Press the red **Power** button.
 - b. On the Today screen, tap the Antenna icon and select **Wireless Manager** in the dialog box.
 - c. Ensure **Phone** is on.
 - d. Press the red **Power** button to suspend the MC75A.
 - e. Perform a warm boot. See [Resetting the MC75A on page 2-17](#).
 - f. Make a call to verify cellular connection.

✓ **NOTE** For detailed information about WWAN activation and settings, refer to the *MC75A Integrator Guide*.

Installing the Main Battery

✓ **NOTE** The MC75A ships with either a 1950 mAh or a 3600 mAh battery. An optional 4800 mAh battery is available.

To install the main battery:

1. Insert the battery, top first, into the battery compartment in the back of the MC75A.

✓ **NOTE** Position the battery correctly, with the battery charging contacts on top of the charging contacts in the battery compartment.

2. Press the battery down into the battery compartment until the battery release latch snaps into place.

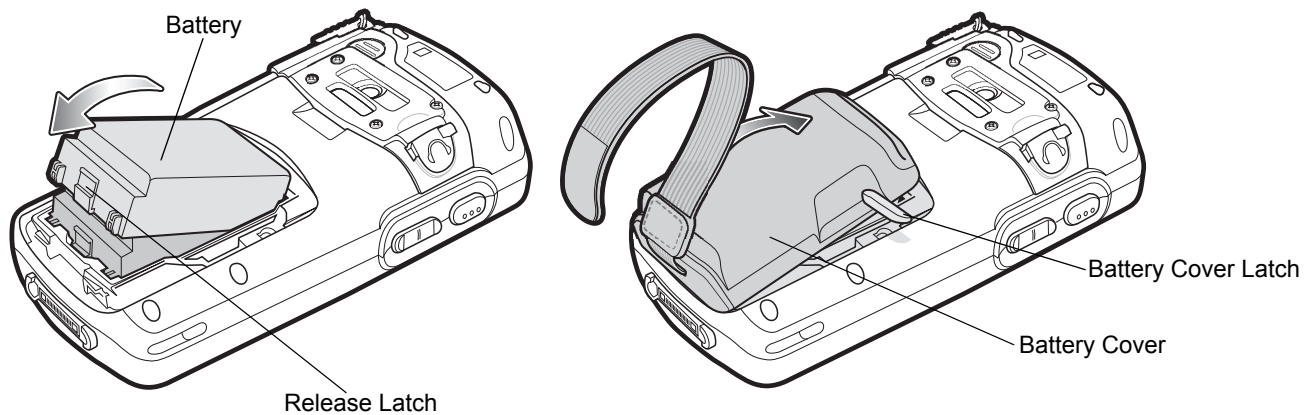

Figure 1-5 *Inserting the Battery*

3. With the battery cover latches open, insert the cover, bottom first, then press down on the top of the cover.
4. Close the battery cover latches on either side of the battery cover.
5. Insert the handstrap through the handstrap slot, then tighten and press down to secure.

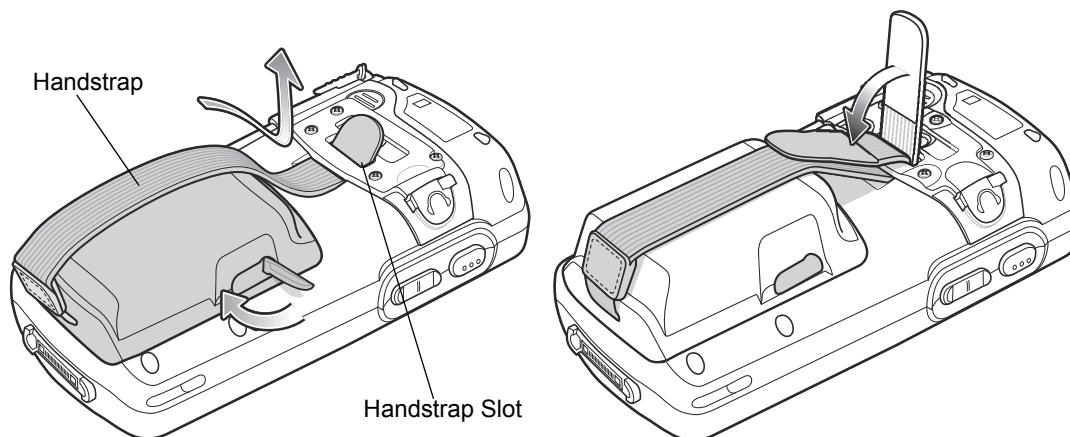

Figure 1-6 *Inserting the Handstrap*

The MC75A powers up after inserting the battery and replacing the battery cover.

Charging the Battery



CAUTION Ensure that you follow the guidelines for battery safety described in [Battery Safety Guidelines on page 8-2](#).

Charging the Main Battery and Memory Backup Battery

Before using the MC75A for the first time, charge the main battery until the amber Charging/Battery Status LED remains lit (see [Table 1-2 on page 1-7](#) for charge status indications). To charge the MC75A, use a cable or a cradle with the appropriate power supply. For information about the accessories available for the MC75A, see [Chapter 7, Accessories](#).

The MC75A is equipped with a memory backup battery which automatically charges from the fully-charged main battery. When using the MC75A for the first time, the backup battery requires approximately 36 hours to fully

charge. This is also true any time the backup battery is discharged, which occurs when the main battery is removed for several hours. The backup battery retains RAM data in memory for at least 15 minutes (at room temperature) when the MC75A's main battery is removed. When the MC75A reaches a very low battery state, the combination of main battery and backup battery retains RAM data in memory for at least 48 hours.

To charge the main battery, use either a charging cable or a cradle. For cable and cradle setup and charging procedures refer to the *MC75A Integrator Guide*.

- Single Slot USB/Serial Cradle
- Four Slot Ethernet Cradle
- Four Slot Charge Only Cradle
- Vehicle Cradle.

To charge the main battery:

1. Connect the charging accessory to the appropriate power source.
2. Insert the MC75A into a cradle or attach to a cable. The MC75A begins charging. The Charging/Battery Status LED blinks amber while charging, then turns solid amber when fully charged. See [Table 1-2](#) for charging indications.

[Table 1-1](#) lists the charge times for each available battery:

Table 1-1 *Battery Charge Times*

Battery Size	Charge Time
1950 mAh	Changes in less than four hours.
3600 mAh	Changes in less than eight hours.
4800 mAh	Changes in less than ten hours.

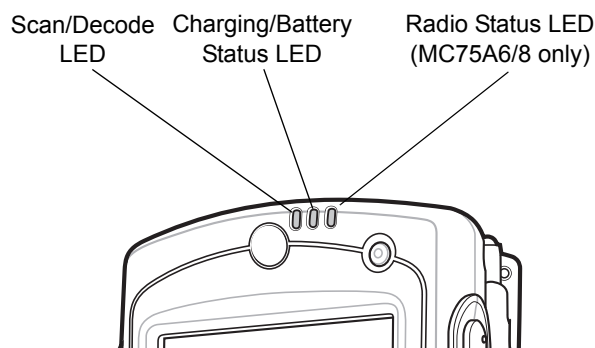

Figure 1-7 *LED Indicators*

Table 1-2 LED Charge Indications

Charging/Battery Status LED	Indication
Off	MC75A is not charging. MC75A is not inserted correctly in the cradle or connected to a power source. Charger/cradle is not powered.
Slow Blinking Amber (1 blink every 2 seconds)	MC75A is charging.
Solid Amber	Charging complete. Note: When the battery is initially inserted in the MC75A, the amber LED flashes once if the battery power is low or the battery is not fully inserted.
Fast Blinking Amber (2 blinks/second)	Charging error, e.g.: <ul style="list-style-type: none"> • Temperature is too low or too high. • Charging has gone on too long without completion (typically eight hours).

Charging Spare Batteries

See [Chapter 7, Accessories](#) for information on using accessories to change spare batteries.

Charging Temperature

Charge batteries in temperatures from 0°C to 40°C (32°F to 104°F). Charging is intelligently controlled by the MC75A.

To accomplish this, for small periods of time, the MC75A or accessory alternately enables and disables battery charging to keep the battery at acceptable temperatures. The MC75A or accessory indicates when charging is disabled due to abnormal temperatures via its LED. See [Table 1-2](#).

Powering On the MC75A

Press the **Power** button to turn on the MC75A. If the MC75A does not power on perform a warm boot. See [Resetting the MC75A on page 2-17](#).

When turning the MC75A on for the first time, the splash screen displays for about a minute as the MC75A initializes its flash file system, then the calibration window appears. Note that these windows also appear upon cold boot.



NOTE When the MC75A powers up after inserting a battery for the first time, the device boots and powers on automatically.

Calibrating the Screen



NOTE The Calibration screen can be accessed by pressing **Blue** key - **BKSP** key or tapping **Start > Settings > Screen > Align Screen** button.

To calibrate the screen so the cursor on the touch screen aligns with the tip of the stylus:

1. Remove the stylus from its holder on the back of the MC75A.
2. Tap the screen to begin calibration.

3. Carefully press and briefly hold the tip of stylus on the center of each target that appears on the screen.
4. Repeat as the target moves around the screen.

Checking Battery Status

To check the charge status of the main battery or backup battery in the MC75A, tap **Start** > **Settings** > **Power** icon to display the **Power** window.

To save battery power, tap the **Advanced** tab and set the MC75A to turn off after a specified number of minutes.

Micro Secure Digital (microSD) Card

The microSD card slot provides secondary non-volatile storage. The slot is located on the side of the MC75A (see [Figure 1-8](#)). Refer to the documentation provided with the card for more information, and follow the manufacturer's recommendations for use.



CAUTION Follow proper ESD precautions to avoid damaging the microSD card. Proper ESD precautions include, but are not limited to, working on an ESD mat and ensuring that the operator is properly grounded.

To install the microSD card:

1. Remove the memory card cover on the side of the MC75A by loosening the two captive screws.

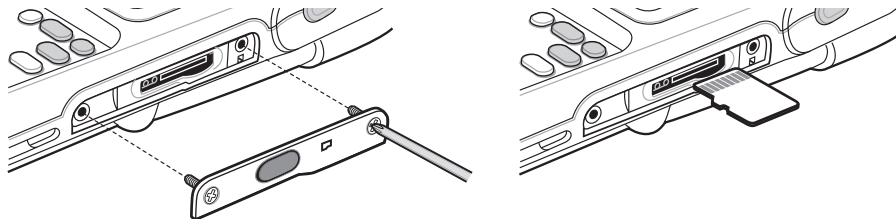

Figure 1-8 Card Installation

2. Insert the card with the card contacts facing up, until you feel a click.
3. Replace the memory card cover and tighten the screws.

To remove an microSD card:

1. Remove the memory card cover by loosening the two captive screws.

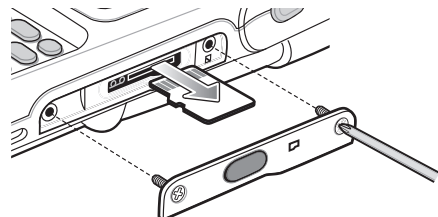

Figure 1-9 Card Removal

2. Carefully press and release the card to eject it.
3. Remove the card from the card slot.

4. Replace the memory card cover and tighten the screws.

Adjusting the Handstrap

The MC75A handstrap is attached to the bottom of the battery cover. Adjust the handstrap to increase comfort when holding the MC75A for extended periods of time. To adjust the handstrap:

1. Feed the handstrap through the handstrap slot.
2. Secure the handstrap by pressing the two sides together as shown in [Figure 1-10](#).

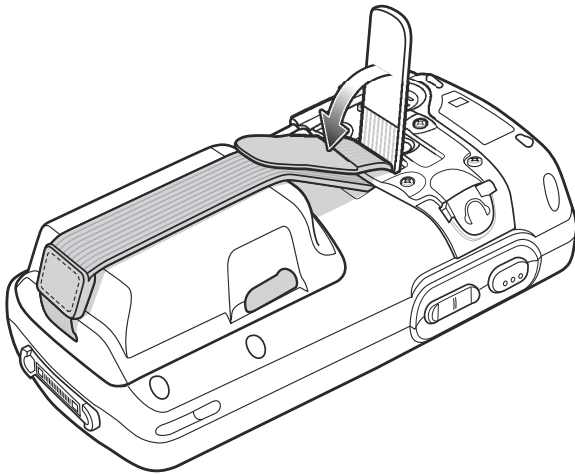

Figure 1-10 Handstrap Adjustment

Replacing the Main Battery

3. If the MC75A is in suspend mode, press the red **Power** button to wake the device.
4. Press the red **Power** button to suspend the MC75A.
5. Wait for red Decode LED to turn on and then turn off.
6. Open the battery cover latches on either side of the battery cover.

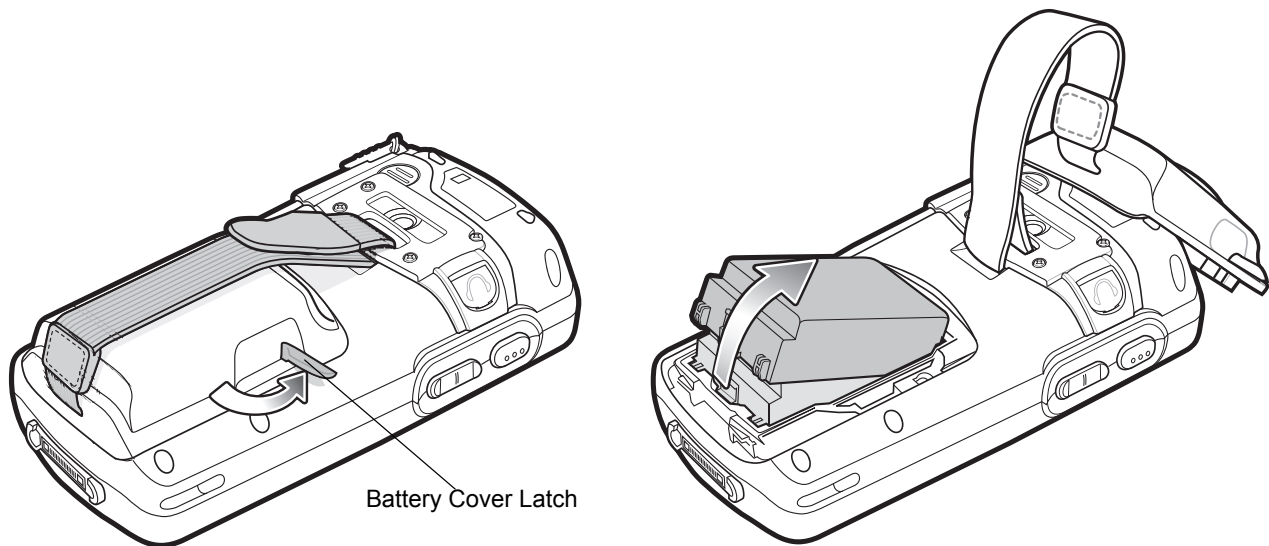

Figure 1-11 *Removing the Battery Cover*

7. Lift the top of the battery cover and remove.
8. Press the battery release latch on the bottom of the battery to unlock, and lift the battery out of the well.
9. Insert the replacement battery, top first, into the battery compartment in the back of the MC75A.
10. Press the battery down into the battery compartment until the battery release latch snaps into place.

✓ **NOTE** Position the battery correctly, with the battery charging contacts on top of the charging contacts in the battery compartment.

11. With the battery cover latches open, insert the cover, bottom first, then press down on the top of the cover.
12. Close the battery cover latches on either side of the battery cover.
13. Press the red Power button to power on the MC75A.

Battery Management

Observe the following battery saving tips:

✓ **NOTE** The MC75A factory default settings for the WWAN and WLAN radios are set to ON.

- Leave the MC75A connected to AC power at all times when not in use.
- Set the MC75A to turn off after a short period of non-use.
- Set the backlight to turn off after a short period of non-use.
- Turn off all wireless activities when not in use.
- Power off the MC75A when charging to charge at a faster rate.
- Set IST to turn the display off or to suspend when the MC75A is placed face down.

Changing the Power Settings

To set the MC75A to turn off after a short period of non-use:

1. Tap **Start > Settings > System tab > Power icon > Advanced tab**.
2. Select the **On battery power: Turn off device if not used for** check box and select a value from the drop-down list.
3. Select **ok**.

Changing the Backlight Settings

To change the backlight settings in order to conserve more battery power:

1. Tap **Start > Settings > System tab > Backlight icon > Battery Power tab**.
2. Select the **Disable backlight if device is not used for** check box and select a value from the drop-down list.
3. Select the **Brightness tab**.
4. Tap the **Disable backlight** check box to turn off the display backlight, or use the slider to set a low value for the backlight.
5. Select **ok**.

Changing the Keypad Backlight Settings

To change the keypad backlight settings in order to conserve more battery power:

1. Tap **Start > Settings > System tab > Keypress icon > Battery Power tab**.
2. Select the **On battery power: Disable keylight if device if not used for** check box and select a value from the drop-down list.
3. Select the **Advanced tab**.
4. Tap the **Disable keylight** check box to turn off the keypad backlight.
5. Select **ok**.

Turning Off the Radios

Windows Mobile 6 devices include **Wireless Manager**, which provides a simple method of enabling, disabling, and configuring all the device's wireless capabilities in one place.

To open **Wireless Manager**, tap the **Connectivity** icon or tap **Wireless Manager** on the **Today** screen.

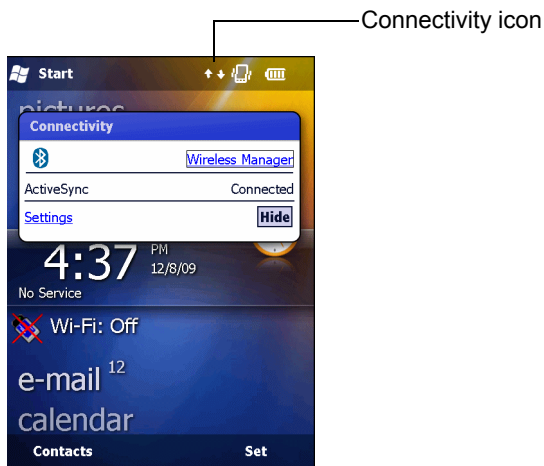

Figure 1-12 Opening Wireless Manager

Select **Wireless Manager**.

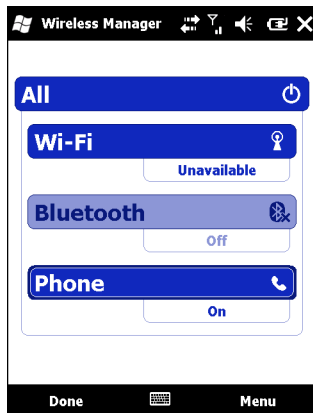

Figure 1-13 Wireless Manager Window



NOTE Wireless connection options vary depending upon configurations.

To enable or disable a wireless connection, tap the specific button.

To enable or disable all wireless connections, tap the **All** button.

To configure settings for a connection, tap **Menu**.

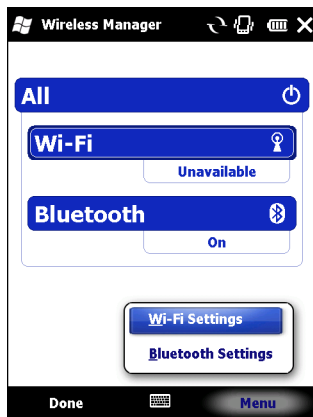

Figure 1-14 *Wireless Manager Menu*

Chapter 2 Using the MC75A

Introduction

This chapter explains the buttons, status icons, and controls on the MC75A, and provides basic instructions for using the MC75A, including powering on and resetting the MC75A, and entering and capturing data.

The MC75A factory default radio states are:

- Wireless LAN - ON
- Bluetooth - OFF
- Phone - ON.

Home Screen

The Home contains the Status Bar at the top of the screen, the Today screen in the center and the Soft Keys at the bottom of the screen.

Each of these are described below.

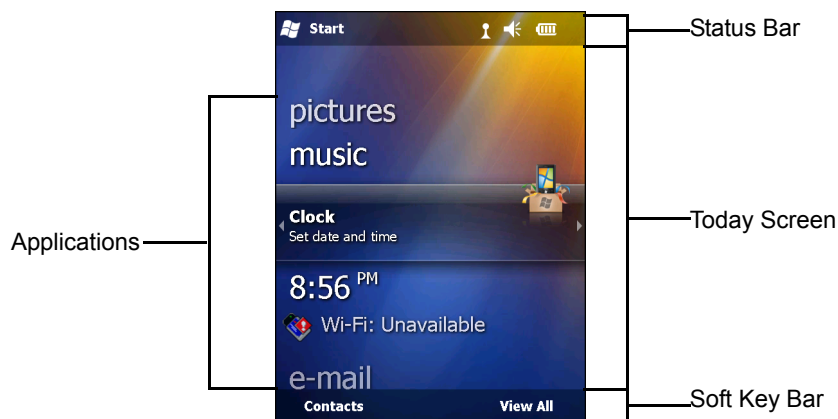

Figure 2-1 Home Screen

Status Bar

The Status Bar at the top of the screen can contain the status icons listed in [Table 2-1](#).

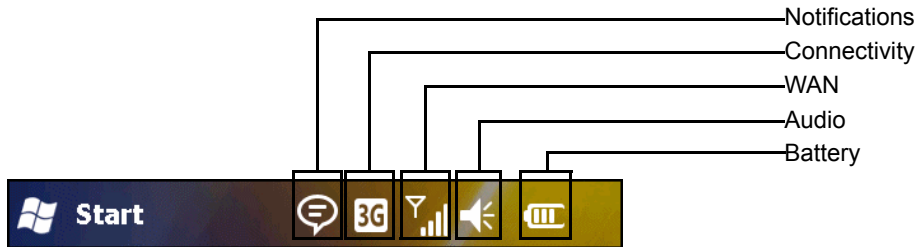

Table 2-1 Status Icons

Icon	Description
Notifications	
	Backup battery low.
	Notification that one or more instant messages were received.
	Notification that one or more e-mail/text messages were received.
	Notification that one or more voice messages were received.
	Speakerphone is on.
	There are more notification icons than can be displayed. Tap to display remaining icons.
	Indicates a reminder of an upcoming calendar event.
Connectivity	
	Connection is active.
	Connection is not active.
	Synchronization is occurring.
	Wi-Fi available.
	Wi-Fi in use.
	HSDPA available. (MC75A6)
	3G available. (MC75A6)
	GPRS available. (MC75A6)
	EGPRS available. (MC75A6)
	1xRTT available. (MC75A8)
	EVDO Rev. 0 available. (MC75A8)
	EVDO Rev. A available. (MC75A8)
	Dormant State - no data transmission during a 1x or EVDO connection. (MC75A8)

Table 2-1 Status Icons (Continued)





























Icon	Description
	Call missed.
WAN	
	Dialing while no SIM card is installed.
	Voice call in progress.
	Calls are forwarded.
	Call on hold.
	Antenna/signal icon: wireless on/good signal.
	Antenna/signal icon: wireless off.
	Antenna/signal icon: no service or searching.
	HSDPA connecting. (MC75A6)
	HSDPA in use. (MC75A6)
	3G connecting. (MC75A6)
	3G in use. (MC75A6)
	GPRS connecting. (MC75A6)
	GPRS in use. (MC75A6)
	EGPRS connecting. (MC75A6)
	EGPRS in use. (MC75A6)
	EVDO connecting. (MC75A8)
	EVDO in use. (MC75A8)
	Roaming.
	SIM Card not installed. (MC75A6)
Audio	
	All sounds are on.
	All sounds are off.
	Vibrate is on.
Battery	
	Main battery is charging.
	Main battery has a full charge.
	Main battery has a high charge.

Table 2-1 *Status Icons (Continued)*

Icon	Description
	Main battery has a medium charge.
	Main battery has a low charge.
	Main battery has a very low charge.

Today Screen

The Today screen is scrollable and contains a list of applications and an Information Status bar. The Information Status bar highlights the application that is under it and provides additional information.

Touch and hold the screen with your finger and move the Today screen up and down. As the application names move under the Information Status bar, information relevant to that application appears in the bar.

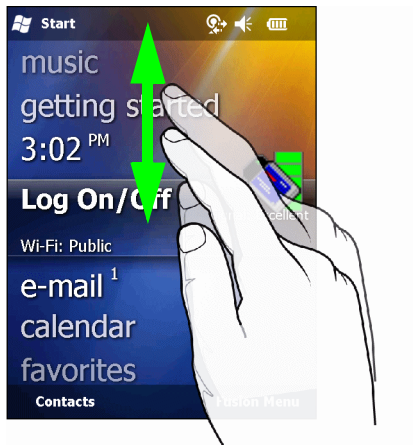
**Figure 2-2** *Moving Today Screen*

You can also touch and hold the Information Status bar and move it up and down over an application name. Remove your finger and the Information Status bar and application name center in the screen.

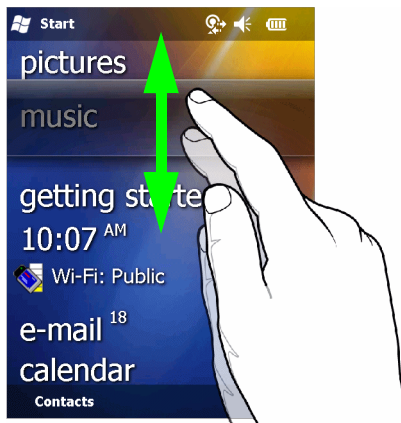
**Figure 2-3** *Moving Information Status Bar*

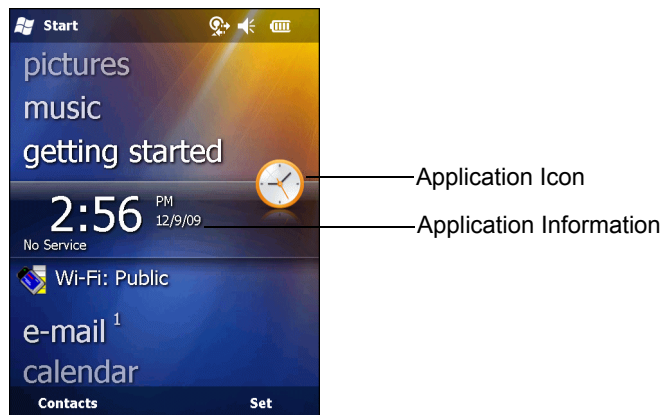

Figure 2-4 Information Bar Example

To customize the **Today** screen, tap **Start > Settings > Today** icon. Use the **Appearance** tab to customize the background and the **Items** tab to change the display format.

Classic Today Screen

The user can change the Today screen to the classic layout that is used in Windows Mobile 6.1.

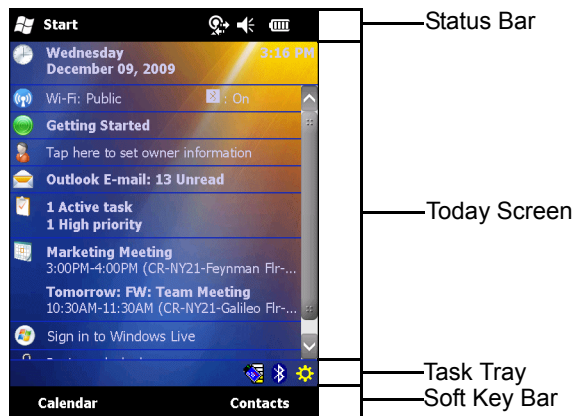

Figure 2-5 Classic Today Screen

To change to the classic view tap **Start > Settings > Today** icon > **Items** tab.

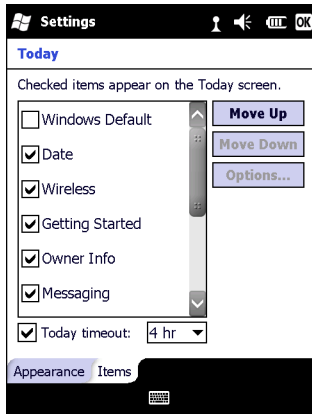

Figure 2-6 Today Screen Settings







Deselect the **Windows Default** checkbox and select any of the other checkboxes.

Tap **OK**.

✓ **NOTE** The task bar is only visible in the classic view.

The task bar at the bottom of the screen can contain the task tray icons listed in [Table 2-2](#).

Table 2-2 Task Tray Icons

Icon	Name	Description
	Wireless connection status	Indicates WLAN signal strength.
	Bluetooth Enabled	Bluetooth radio is on. (Available when StoneStreet One Bluetooth stack is enabled).
	Bluetooth Disabled	Bluetooth radio is off. (Available when StoneStreet One Bluetooth stack is enabled).
	Bluetooth Connection	Bluetooth radio is connected to another Bluetooth device. (Available when StoneStreet One Bluetooth stack is enabled).
	ActiveSync	Active serial connection between the MC75A and the host computer.
	IST	Use to configure the interactive sensing feature.

Soft Keys Bar

The Soft Key bar is located at the bottom of the screen and contains two soft key buttons. These buttons display an action and a menu to the user that are context sensitive and can be changed dynamically by an application. For example, in the Contacts list view, the soft keys are **New** and **Menu**. As the user begins creating a new contact in edit view, the soft keys change to **Done** and **Menu**.

Start Screen

The Start screen lists applications and folders available to the user. [Table 2-3](#) lists the default programs and folders listed on the **Start** screen.



Figure 2-7 Start Screen

Table 2-3 Programs and Folders on the Start Screen















Icon	Name	Description	Icon	Name	Description
	Today	Close the Start menu and display the Today screen.		E-mail	Send an Email.
	Text	Send an SMS text message.		Contacts	Keep track of friends and colleagues.
	Calendar	Keep track of appointments and create meeting requests.		Internet Explorer	Browse Web and WAP sites as well as download new programs and files from the Internet.
	Settings	Open the Settings folder. See Settings Folder on page 2-10 .		Pictures & Videos	View and manage pictures, animated GIFs, and video files.
	Getting Started	Launch the Getting Started application.		Windows Media	Play back audio and video files.
	Messenger	Use this mobile version of Windows Live Messenger.		Marketplace	Purchase applications from the Marketplace.
	Phone	Make and receive calls, switch between calls, and set up conference calling.		Microsoft My Phone	Synchronizes the MC75A's contacts, calendar, tasks, text messages, music, photos videos and documents with a Microsoft My Phone account.

Table 2-3 Programs and Folders on the Start Screen (Continued)



























Icon	Name	Description	Icon	Name	Description
	Windows Live	Use this mobile version of Windows Live™ to find information on the web.		MSN Weather	Check the local weather.
	Games	Play games.		MSN Money	Keep track of your finances.
	Notes	Create handwritten or typed notes, drawings, and voice recordings.		Calculator	Perform basic arithmetic and calculations, such as addition, subtraction, multiplication, and division.
	Tasks	Keep track of your tasks.		File Explorer	Organize and manage files on your device.
	ActiveSync	Synchronize information between the MC75A and a host computer or the Exchange Server.		Office Mobile	Use the complete suite of Microsoft® Office applications for your mobile device. Excel Mobile OneNote Mobile PowerPoint Mobile Word Mobile
	Internet Sharing	Connect a notebook computer to the Internet using the MC75A's data connection.		Task Manager	Enables viewing of memory and CPU allocations and stops running processes. Refer to the <i>Microsoft Applications for Windows Mobile 6 User Guide</i> for more information.
	Search Phone	Search contacts, data, and other information on the MC75A. Refer to the <i>Microsoft Applications for Windows Mobile 6 User Guide</i> for more information.		Wireless Companion Folder	Open the Wireless Companion folder.
	Help	See Help topics for the current screen or program.		AirBEAM Client	Allows specially designed software packages to be transferred between a host server and the MC75A. Refer to the <i>MC75A Integrator Guide</i> for more information.









Table 2-3 Programs and Folders on the Start Screen (Continued)

Icon	Name	Description	Icon	Name	Description
	BT Information	Display information about the Bluetooth radio and generate a Bluetooth address bar code.		BTScanner CtlPanel	Set com port to use with a Bluetooth scanner.
	BTE Explorer	Manages Bluetooth connections using BTE Explorer. Only available when the StoneStreet One Bluetooth stack is enabled.		Remote Desktop	Log onto Windows NT server type computers and use all of the programs that are available on that computer from the MC75A.
	Modem Link	Enables the MC75A to be used as a modem.		SMS Staging	Intercepts SMS Staging messages and reassembles them into the original Staging Profile.
	MSP Agent	Interacts with MSP agents to collect monitoring and asset information to enable the configuration, provisioning, monitoring and troubleshooting of the MC75A. Refer to the <i>MC75A Integrator Guide</i> for more information.		Rapid Deployment Client	Facilitates software downloads from a Mobility Services Platform Console FTP server to the MC75A. Refer to the <i>MC75A Integrator Guide</i> for more information.
	SIM Toolkit	Manage the contacts that are stored on your SIM card. Copy SIM contents to Contacts on the MC75A.		Search Widget	Install Microsoft application on the MC75A.
	DEMO	Launches the DEMO applications. This icon appears after the DEMO applications have been installed.			

Settings Folder

Table 2-4 lists the setting applications pre-installed on the MC75A. Tap **Start > Settings** to open the **Settings** folder.

Table 2-4 *Setting Applications in the Setting Folder*

Icon	Name	Description	Icon	Name	Description
	Clock & Alarms	Set the device clock to the date and time of your locale or to a visiting time zone when you're traveling. Alarms can also be set at specified days and times of a week.		Power	Check battery power and set the time-out for turning off the display to conserve battery power.
	Lock	Set a password for the MC75A.		Sounds & Notifications	Enable sounds for events, notifications, and more, and set the type of notification for different events.
	Connections Folder	Contains connection applications (see below).		Today	Customize the appearance of the Today screen and the information to display on it.
	Personal Folder	Contains personal applications (see below).		Microsoft My Phone	Synchronizes the MC75A's contacts, calendar, tasks, text messages, music, photos videos and documents with a Microsoft My Phone account.
	System Folder	Contains system applications (see below).			

Connections Folder





	Beam	Set the MC75A to receive incoming IrDA beams.		Connections	Set up one or more types of modem connections for your device, such as phone dial-up, GPRS, Bluetooth, and more, so that your device can connect to the Internet or a private local network.
	Bluetooth	Open the Bluetooth application, set the MC75A to visible mode and scan for other Bluetooth devices in the area.		Domain Enroll	Make your device an AD domain member for device management and security. Refer to the <i>Microsoft Applications for Windows Mobile 6 User Guide</i> for more information.

Table 2-4 *Setting Applications in the Setting Folder (Continued)*















Icon	Name	Description	Icon	Name	Description
	Wi-Fi	Setup wireless network connection and customize settings.		USB to PC	Enables or disables the enhanced network connectivity.
	Wireless Manager	Enables or disables the MC75A's wireless radios and customizes Wi-Fi, and Bluetooth settings.			
Personal Folder					
	Buttons	Assign a program to a button.		Owner Information	Enter personal information on the MC75A.
	Input	Set options for each of the input methods.		Phone	Configure phone settings.
System Folder					
	About	View basic information such as the Windows Mobile® version and type of processor used on the MC75A.		Certificates	See information about certificates installed on the MC75A.
	Backlight	Set the display backlight time-out and adjust brightness.		Customer Feedback	Submit feedback on the Windows Mobile 6 software.
	Error Reporting	Enable or disable the device's error reporting function. When this function is enabled and a program error occurs, technical data about the state of the program and your computer is logged in a text file and delivered to Microsoft's technical support if you choose to send it.		Encryption	Allow files on a storage card to be encrypted. Encrypted files are readable only on your device.
	External GPS	Set the appropriate GPS communication ports, if required. You may need to do this when there are programs on the device that access GPS data or you have connected a GPS receiver to the device.		HAC Settings	Control the phone's HAC feature.

Table 2-4 *Setting Applications in the Setting Folder (Continued)*

Icon	Name	Description	Icon	Name	Description
	GPS Setup	View GPS SUPL information.		IST Settings	Set the appropriate setting for configuring the device's interactive Sensor Technology.
	Managed Programs	Displays the programs that were installed on the MC75A using Mobile Device Manager.		Keylight	Set the keypad backlight time-out.
	Memory	Check the device memory allocation status and memory card information and stop currently running programs.		Regional Settings	Set the regional configuration to use, including the format for displaying numbers, currency, date, and time on the MC75A.
	Phone Info	View phone information.		Remove Programs	Remove programs that you installed on the MC75A.
	System Info	Displays the MC75A's software and hardware information.		Screen	Change the screen orientation, re-calibrate the screen, and change the screen text size.
	Task Manager	Stop running programs.		Trigger Settings	Enables the MC75A to use the Snap-on Trigger Handle.

Adjusting Volume

To adjust the system volume using the **Speaker** icon in the navigation bar:

1. Tap the **Speaker** icon. The **Volume** dialog box appears.

**Figure 2-8** *Volume Dialog Box*

2. Tap and move the slide bar to adjust the volume.
3. Select the **On** or **Off** radio button to turn the volume on or off.

You can also adjust the system volume using the **Sounds & Notifications** window, or use the **Up/Down** button on the side of the MC75A.

Battery Status Indications

Battery icons appear on the navigation bar indicating the battery power level. When the main battery or backup battery power falls below a predetermined level the icon indicates the status and a battery dialog box appears indicating the status of the main or backup battery.

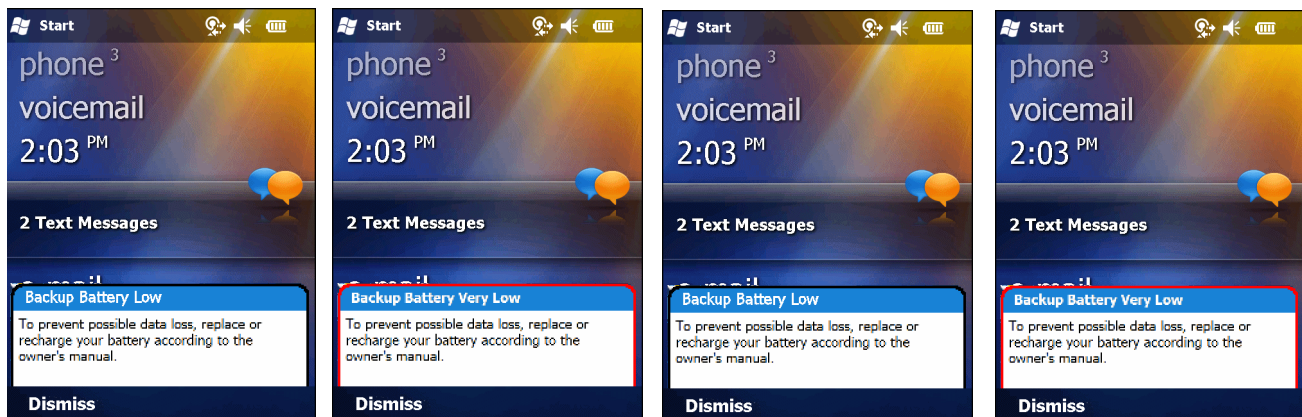

Figure 2-9 Battery Status Dialog Box

The **Battery** icon always appears in the **navigation bar** when the Today screen is visible. The icon indicates the battery power level. The message displays until the **Dismiss** button is pressed.



Figure 2-10 Battery Icon on the Title Bar

Also view the battery status using the **Power** window.

Battery Reserve Options

If the charge of the battery reaches a critical threshold, the MC75A shuts down. This threshold can be changed but affects the amount of time that data can be retained.

1. Tap **Start > Settings > Power icon > RunTime** tab. A warning message appears.

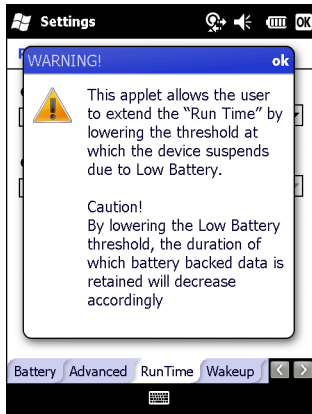

Figure 2-11 Warning Message

2. Read the warning message and tap **OK**.

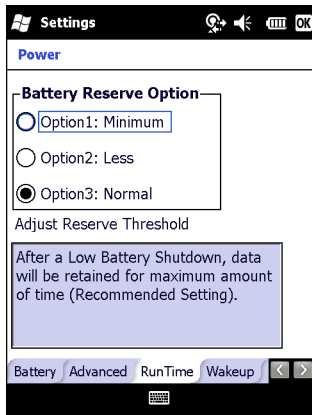

Figure 2-12 RunTime Tab

3. Select one of the **Battery Reserve Options**.
 - **Option 1: Minimum** - After a low battery shutdown, data will be retained for minimum amount of time. Battery should be replaced immediately to avoid data loss.
 - **Option 2: Less** - After a low battery shutdown, data will be retained for less than normal amount of time.
 - **Option 3: Normal** - After a low battery shutdown, data will be retained for maximum amount of time.
4. Tap **OK**.

Main Battery Temperature Notifications

The temperature notification system implements three levels of notification when the temperature within the battery exceeds specific temperature thresholds:

- **Level 1: Temperature Watch**; this level is similar to main battery low warning. It indicates that the battery temperature has reached the first threshold level. The user should move to an environment within proper operating temperature.
- **Level 2: Temperature Warning**; this level is similar to main battery very low warning. It indicates the battery temperature has reached the second threshold level. The user should stop using the MC75A.

- **Level 3: Temperature Error**; this level indicates the battery has reached an unusable temperature threshold and immediately suspends the MC75A. This level does not have any graphical notification associated with it.



Figure 2-13 Main Battery Temperature Watch Dialog Box

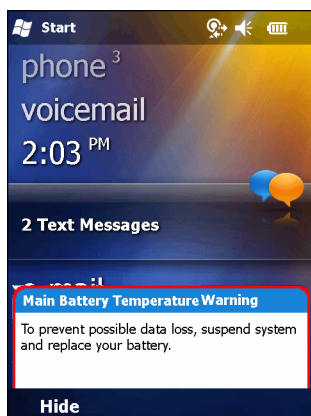

Figure 2-14 Main Battery Temperature Warning Dialog Box



NOTE The **Temperature Warning** dialog box remains visible until you tap **Hide**.

LED Indicators

The MC75A has three LED indicators. The Scan/Decode LED indicates status for bar code scanning. The Charging/Battery Status LED indicates battery charging and status. The third LED is application programmable.

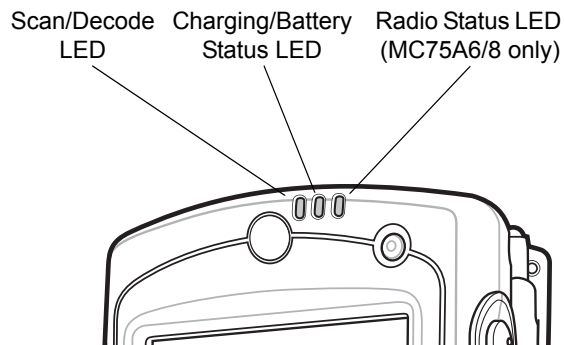

Figure 2-15 LED Indicators

Table 2-5 LED Indications

LED State	Indication
Scan/Decode LED	
Solid Green	Successful decode/capture.
Solid Red	Laser enabled, scanning/imaging in process.
Blink Red	MC75A is going into suspend mode.
Off	Not enabled.
Charging/Battery Status LED	
Slow Blinking Amber	Main battery in MC75A is charging.
Solid Amber	Main battery in MC75A is fully charged.
Fast Blinking Amber	Charging error.
Off	Not charging.
Single Blink Amber (when Power button pressed)	Battery depleted.
Blinking Amber (when Power button pressed)	Battery over-temperature condition.
Radio Status LED	
Slow Blinking Green	WAN radio is on.
Off	WAN radio is off.

✓ **NOTE** For information about scanning/decoding, see [Chapter 3, Data Capture](#). For information about WAN radio status and settings, see [Chapter 4, Using the Phone](#), or refer to the *MC75A Enterprise Digital Assistant Integrator Guide*.

Resetting the MC75A

There are two reset functions, warm boot and cold boot. A warm boot restarts the MC75A by closing all running programs. A cold boot also restarts the MC75A, and also resets the clock. Data saved in flash memory or a memory card is not lost.

If the MC75A is not functioning properly, perform a warm boot first. If the MC75A still does not respond, perform a cold boot.

Performing a Warm Boot

Hold down the **Power** button for approximately five seconds. As soon as the MC75A starts to boot release the **Power** button.



Figure 2-16 Warm Boot Splash Screen

Performing a Cold Boot

To perform a cold boot simultaneously press the **Power** button and the **1** and **9** keys.

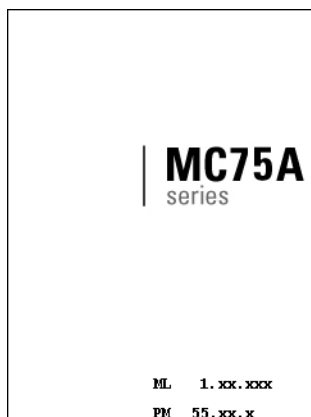

Figure 2-17 Cold Boot Splash Screen

Waking the MC75A

The wake-up conditions define what actions wake up the mobile computer after it has gone into suspend mode. The mobile computer can go into suspend mode by either pressing the Power button or automatically by Control Panel time-out settings. These settings are configurable and the factory default settings are shown in are subject to change/update.

Table 2-6 Wake-up Default Settings

Condition for Wake-up	Power Button	Automatic Time-out
AC power is applied.	No	Yes
Mobile computer is inserted into a cradle.	No	Yes
Mobile computer is removed from a cradle.	No	Yes
Mobile computer is connected to a USB device.	No	Yes
Mobile computer is disconnected from a USB device.	No	Yes
A key is pressed.	No	Yes
The scan triggered is pressed.	No	Yes
The screen is touched.	No	No
Audio Jack	No	No
Audio Btn	No	No
Bluetooth communication	Yes	Yes
Incoming phone call	Yes	Yes
On motion	No	Yes

Locking the MC75A

Use the Device Lock feature to prevent use of the device. Note that when locked, the MC75A does not respond to screen or keypad input.

To lock the MC75A, tap **Start > Lock**. The **Lock** screen appears.

To unlock the MC75A, slide the **Lock** button to the left or right.

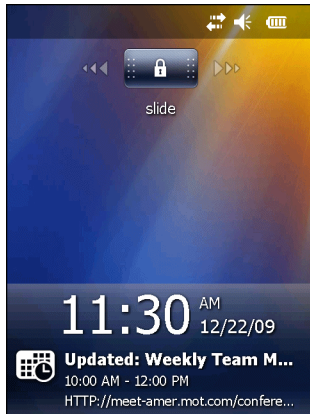

Figure 2-18 *Unlock Device Window*

If the MC75A was locked with a password, a prompt appears for the password.

Password Locking

Use the **Password** window to set a password to disable unauthorized access to the MC75A.

- ✓ **NOTE** If the device is configured to connect to a network, use a strong (difficult to figure out) password to help protect network security. Password cracking tools continue to improve and the computers used to crack passwords are more powerful than ever.

1. Tap **Start > Settings > Lock icon > Password** tab.

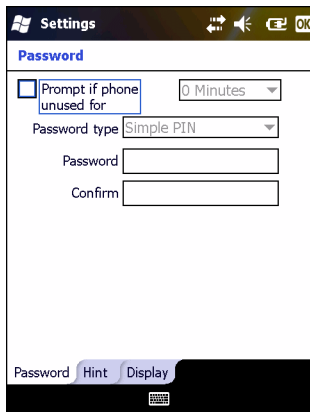

Figure 2-19 *Password Window - Password Tab*

2. Select **Prompt if device unused for** check box to enable password protection.
3. From the drop-down list, select a time value for the protection to take affect after non-use.
4. From the **Password type**: drop-down list, select either **Simple PIN** or **Strong alphanumeric**.
5. For a simple password, enter a four-digit password in the **Password** field.
For a stronger password:
 - a. Enter a seven character password in the **Password**: field. A strong password must contain at least seven characters and contain at least three of the following: uppercase and lowercase letters, numerals, and punctuation.

- b. Re-enter the password in the **Confirm:** field.
6. Tap **OK**.
7. To set a hint to remember the password, tap the **Hint** tab.
8. In the text box, enter a hint for a password reminder.
9. Tap **OK**.

When the MC75A is not used for a period of time and the user tries to access the device, the Password window appears. This also appears when the MC75A is connected to a host computer with either a cradle or communication cable.

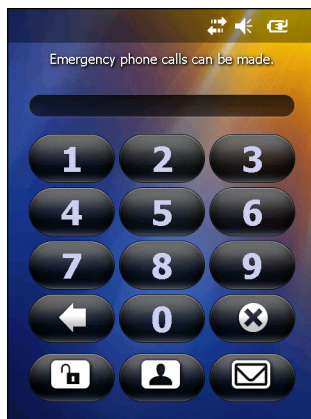

Figure 2-20 Enter Password Windows

Enter the password to un-lock the device.

Tap the **Unlock** button to unlock the device and go to the Today screen, or tap the **Contact** button to unlock the device and go to the Contacts window or tap the **Email** button to unlock the device and go to the **Messaging** window.

Function Buttons

- ✓ **NOTE** You can make emergency calls even when the MC75A is locked. See for more information.

The MC75A's buttons perform certain functions.

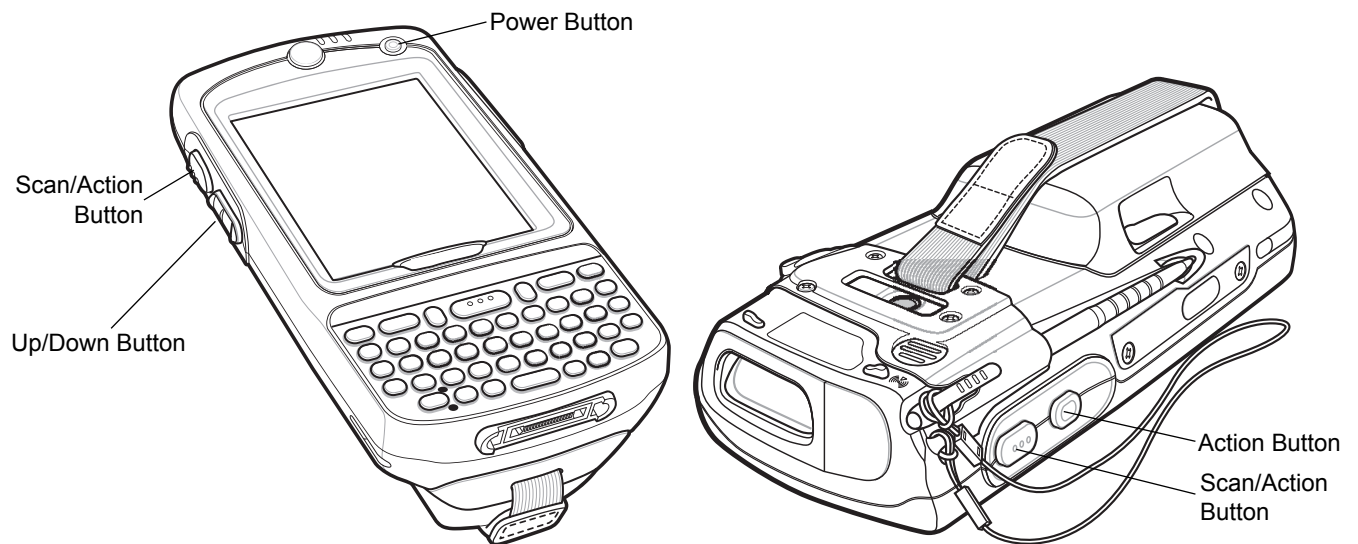

Figure 2-21 Function Buttons

- **Power:** Press the red **Power** button to turn the MC75A screen on and off. The MC75A is in suspend mode when the screen is off. For more information, see [Powering On the MC75A on page 1-7](#). Also use the **Power** button to reset the MC75A by performing a warm or cold boot. See [Resetting the MC75A on page 2-17](#).
- **Scan/Action:** Press to scan bar codes or capture images. See [Chapter 3, Data Capture](#). Or, press to open an application or perform a function. See the *Microsoft® Applications for Mobile 6 User Guide* to set an application to open.
- **Up/Down:** Press to increase or decrease the MC75A's volume.
- **Action:** Press to open an application or perform a function. See the *Microsoft® Applications for Mobile 6 User Guide* to set an application to open.

Stylus

Use the MC75A stylus to select items and enter information. The stylus functions as a mouse.

- **Tap:** Touch the screen once with the stylus to press option buttons and open menu items.
- **Tap and Hold:** Tap and hold the stylus on an item to see a list of actions available for that item. On the pop-up menu that appears, tap the action to perform.
- **Drag:** Hold the stylus on the screen and drag across the screen to select text and images. Drag in a list to select multiple items.



NOTE Zebra recommends using the spring-loaded tip of the stylus to write on the screen, and the back end of the stylus to tap the screen. Use your finger to press the **Power** button and keypad buttons.



CAUTION To prevent damage to the screen, do not use any device other than the Zebra-provided stylus.

Entering Data

When entering data on the keypad, use either the single-hand method or the two-hand method as shown in [Figure 2-22](#).

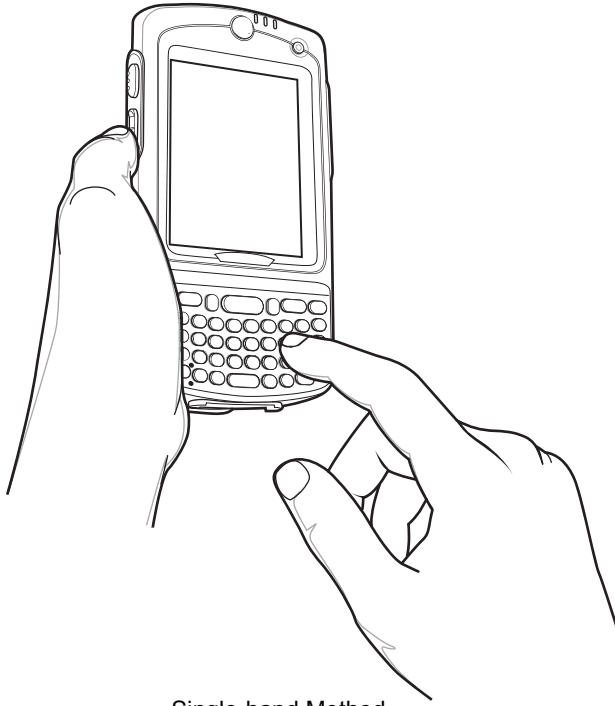

Single-hand Method

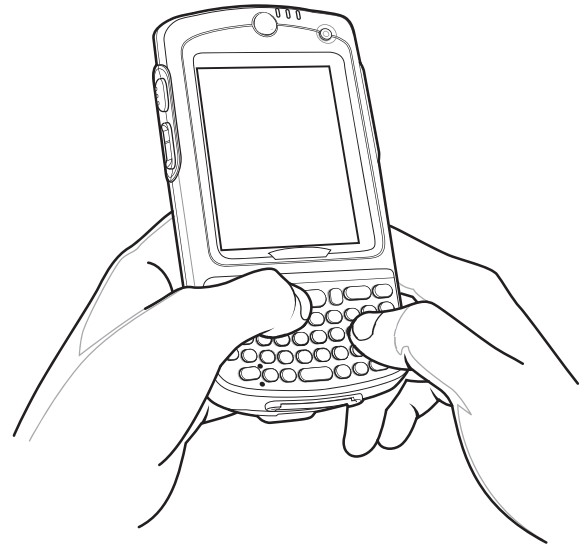

Two-hand Method

Figure 2-22 *Entering Data on the Keypad*

Interactive Sensor Technology

This section describes the functionality of the Interactive Sensor Technology (IST) feature on the MC75A.

The IST supports the following features.

- Power Management – manage power by configuring IST to control switching on/off the backlight, control suspend mode of the MC75A by monitoring motion and orientation.
- Display Orientation – switch the screen orientation to either landscape or portrait depending on the MC75A orientation.
- Free Fall Detection – monitors free fall duration and records the time and type of the drop event.

Power Management

The MC75A orientation and motion sensitive data can be used as an indicator of MC75A usage and can be used to manage the battery power of the mobile computer. For example, IST can be configured to control the backlight on and off functionality or go into suspend according to a user gesture by placing screen facing down. It can also be used to keep the MC75A active while it is in movement to prevent it from quickly going into suspend mode while in use.

Display Orientation

The screen can be rotated between portrait and landscape modes automatically, depending on the physical orientation of the MC75A. For example, if the MC75A is rotated 90° counterclockwise, IST rotates the display counterclockwise 90° so that the screen display appears correct.

This functionality is achieved by monitoring screen angle and rotating the display to counter any changes. IST only rotates the screen in multiples of 90°.

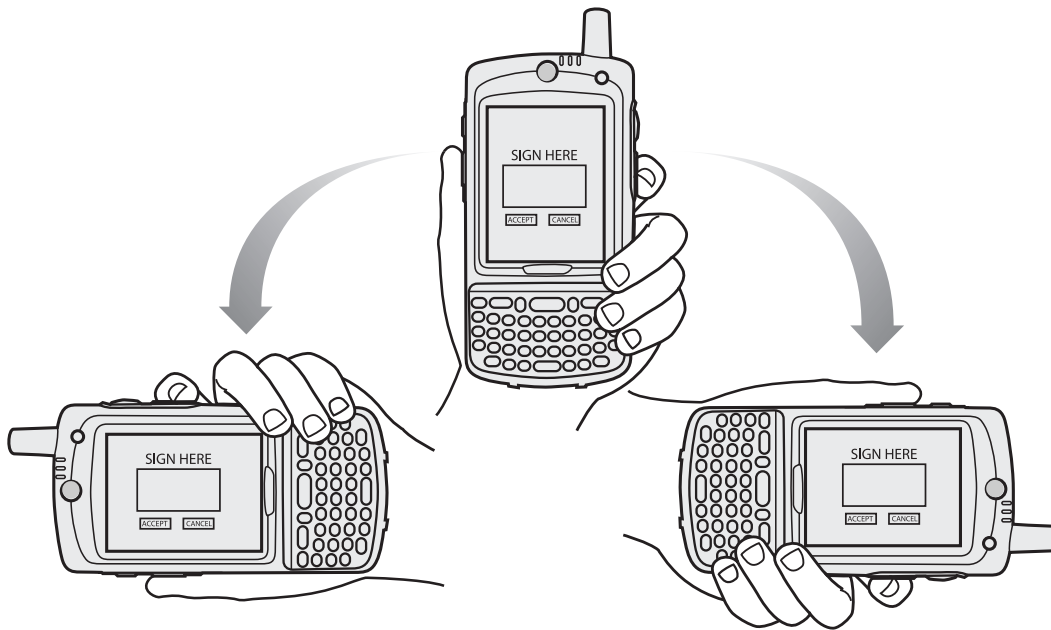

Figure 2-23 *Display Orientation*

Free Fall Detection

IST continuously monitors gravitational force on the MC75A according to its current position. When the MC75A free falls, IST detects the absence of gravitational force and records the event data if it detects a free fall more than 450 ms, which may indicate nearly a one meter drop. This data can be used as an indicator of potential abuse or misuse.

IST features a log for recording the free fall events. This log records the date, time and the time period of the free fall.

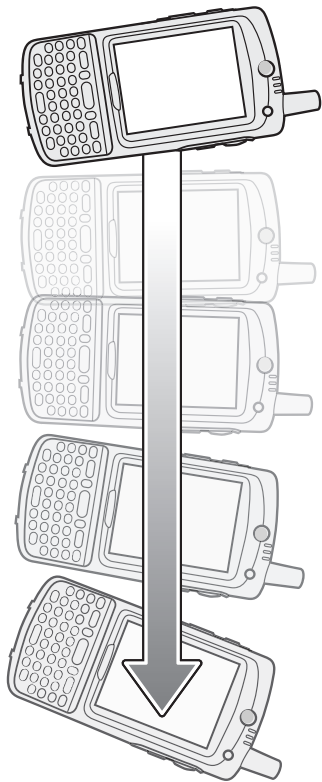

Figure 2-24 Free Fall Detection

Taking Photos

To take a photo:

1. Tap **Start > Pictures & Videos** icon.
2. Tap **Camera** on the command bar.
3. Check the image on the view finder, adjust if necessary.
4. Press the **Enter** key to take the picture. Hold the MC75A still until the camera flash occurs or the shutter sound is heard.

Recording Video

To record a video clip:

1. Tap **Start > Pictures & Videos** icon.
2. Tap **Camera** on the command bar.
3. Tap **Menu > Video** to set shooting mode to video.
The available recording time displays on the screen.

✓ **NOTE** By default, the time limit for recording videos is set to 30 seconds.

4. Press the **Enter** key to begin recording.
Recording stops when you press the **Enter** button again.

Viewing Photos and Videos

✓ **NOTE** For detailed information on the Photos and Videos, refer to the *Microsoft Applications User Guide for Mobile 6*, p/n 72E-108299-xx.

To view photos and video clips:

1. Tap **Start > Pictures & Videos** icon.
2. Tap the picture or video clip to view.

Using IrDA

In a Microsoft Windows Mobile program (except Messaging), and Picture & Videos, you can exchange files using either infrared or Bluetooth.

✓ **NOTE** You can also beam files (not folders) from the **File Explorer** window. Tap and hold the item you want to send, then tap **Beam File** from the pop-up menu.

First activate the beam function before exchanging files with another IrDA device.

To activate the Beam function:

1. Tap **Start > Settings > Connections** folder > **Beam** icon.
2. Tap **Receive all incoming beams** check box.

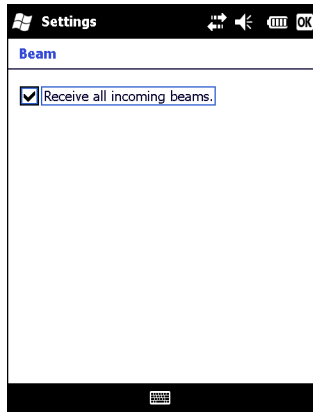

Figure 2-25 *Beam Window*

3. Tap **OK**.

Infrared Connection

Using infrared, you can enable short-range file exchange between your MC75A and another IrDA device.

Exchanging Files using IR Connection

Ensure that the IrDA function on both the MC75A and the other device are enabled.

To send files via IrDA connection:

1. Switch to the program where you created the item you want to send and locate the item in the list.

✓ **NOTE** Do not cover or block the IrDA window.

2. Align the IrDA port of the MC75A with that of the IrDA device so that they are unobstructed and within a close range.

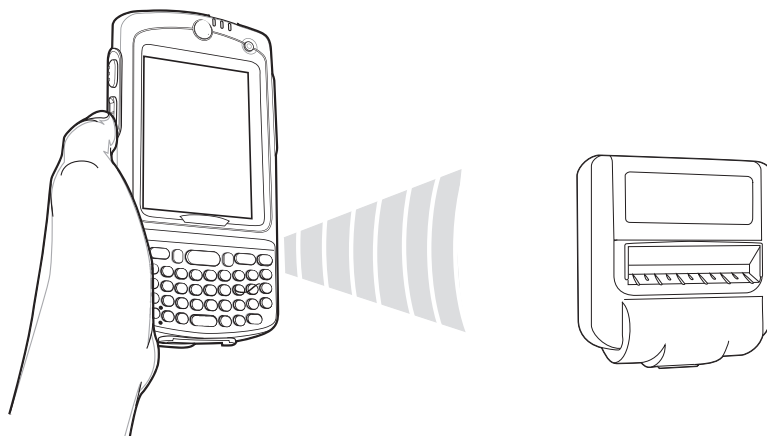

Figure 2-26 *Align MC75A with IrDA Device*

3. Tap and hold the item, then tap Beam [type of item] on the pop-up menu.
4. Tap the device that you want to send the file to.

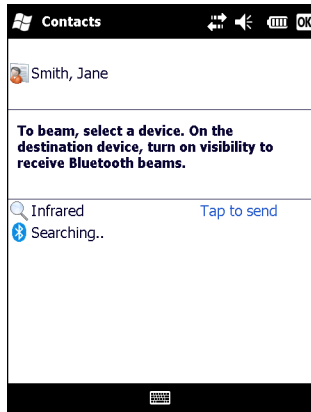

Figure 2-27 Beam Contact

To receive files via IrDA connection:

1. Align the IrDA port of the MC75A with that of the other IrDA device so that they are unobstructed and within a close range.
2. On the other device, send the file to the MC75A.



Figure 2-28 Receive File

3. When the **Receiving Data** dialog displays, tap **Yes**.

Chapter 3 Data Capture

Introduction

The MC75A offers three types of data capture options:

- Laser scanning
- Imaging
- Color digital camera.



NOTE To perform data capture a scanning enabled application must be installed on the MC75A. A sample scanning application can be downloaded from the Zebra Support site at <http://support.symbol.com>.

Laser Scanning

An MC75A with an integrated laser scanner has the following features:

- Reading of a variety of bar code symbologies, including the most popular 1-D code types.
- Intuitive aiming for easy point-and-shoot operation.

Scanning Considerations

Typically, scanning is a simple matter of aim, scan, and decode and a few quick trial efforts master it. However, consider the following to optimize scanning performance:

- Range
Any scanning device decodes well over a particular working range — minimum and maximum distances from the bar code. This range varies according to bar code density and scanning device optics.
Scanning within range brings quick and dependable decodes; scanning too close or too far away prevents decodes. Move the scanner closer or further away to find the right working range for the bar codes being scanned.
- Angle
Scanning angle is important for promoting quick decodes.

- Hold the MC75A farther away for larger symbols.
- Move the MC75A closer for symbols with bars that are close together.

✓ **NOTE** Scanning procedures depend on the application and MC75A configuration. An application may use different scanning procedures from the one listed above.

Bar Code Scanning

1. Ensure that a scan enabled application is loaded on the MC75A.

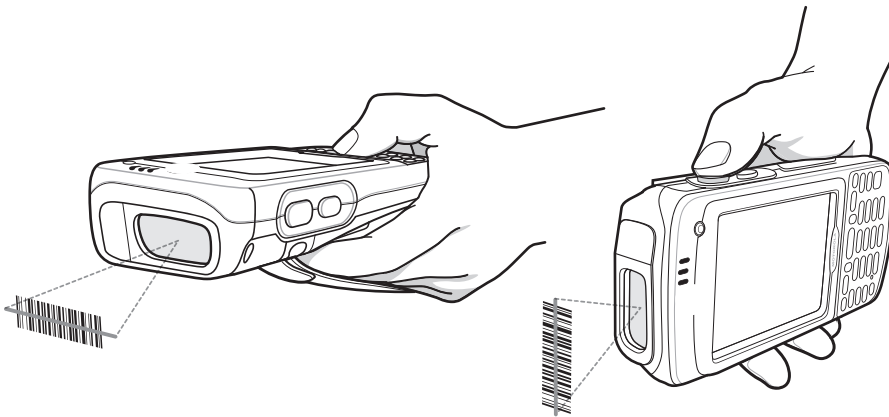

Figure 3-1 Linear Scanning

2. Press and hold the scan button. The laser beam exits from the end of the MC75A. Ensure the red scan beam covers the entire bar code. The Scan/Decode LED lights red to indicate that scanning is in process, then lights green and a beep sounds, by default, to indicate the bar code was decoded successfully.

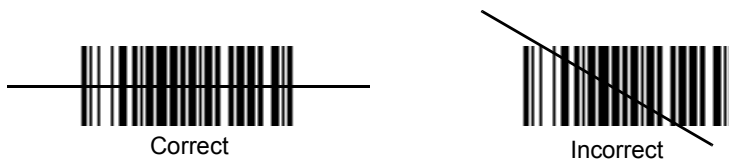

Figure 3-2 Linear Scanner Aiming Pattern

3. Release the scan button.

Imaging

An MC75A with an integrated imager has the following features:

- Omnidirectional reading of a variety of bar code symbologies, including the most popular linear, postal, PDF417, and 2D matrix code types.
- The ability to capture and download images to a host for a variety of imaging applications.
- Advanced intuitive laser aiming for easy point-and-shoot operation.

The imager uses digital camera technology to take a digital picture of a bar code, stores the resulting image in its memory, and executes state-of-the-art software decoding algorithms to extract the data from the image.

Operational Modes

MC75A with an integrated imager support three modes of operation, listed below. Activate each mode by pulling the trigger or pressing the **Scan** button.

- **Decode Mode:** In this mode, the MC75A attempts to locate and decode enabled bar codes within its field of view. The imager remains in this mode as long as you hold the trigger, or until it decodes a bar code.

✓ **NOTE** To enable Pick List Mode, download the Control Panel applet from the web site at <http://support.symbol.com>. Pick List can also be set in an application using a API command.

- **Pick List Mode:** This mode allows you to selectively decode a bar code when more than one bar code is in the MC75A's field of view. To accomplish this, move the aiming crosshair over the required bar code to decode only this bar code. This feature is ideal for pick lists containing multiple bar codes and manufacturing or transport labels containing more than one bar code type (either 1D or 2D).
- **Image Capture Mode:** Use this mode to capture an image within the MC75A's field of view. This is useful for capturing signatures or images of items like damaged boxes.

Imager Scanning

1. Ensure that a scan-enabled application is loaded on the MC75A.

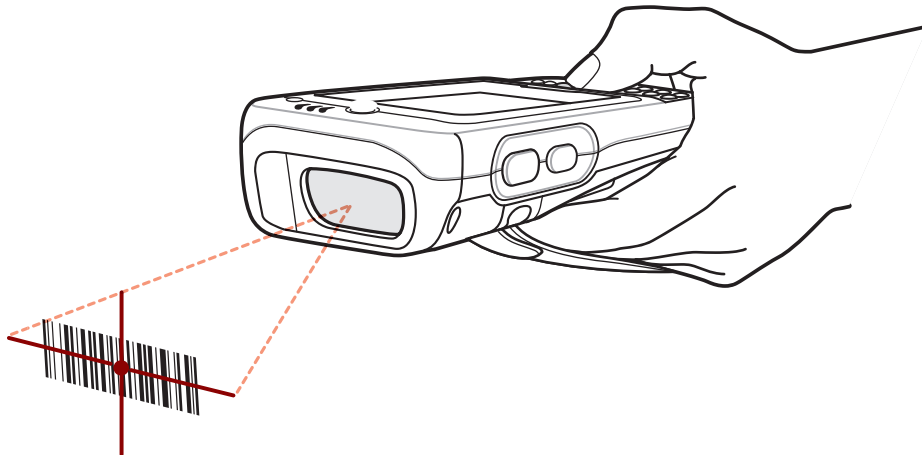

Figure 3-3 *Imager Scanning*

2. Press and hold the scan button. The red laser aiming pattern turns on to assist in aiming. Ensure the bar code is within the area formed by the brackets in the aiming pattern. The Scan/Decode LED lights red to indicate that scanning is in process, then lights green and a beep sounds, by default, to indicate the bar code was decoded successfully. Note that when the MC75A is in Pick List Mode, the imager does not decode the bar code until the crosshair touches the bar code.

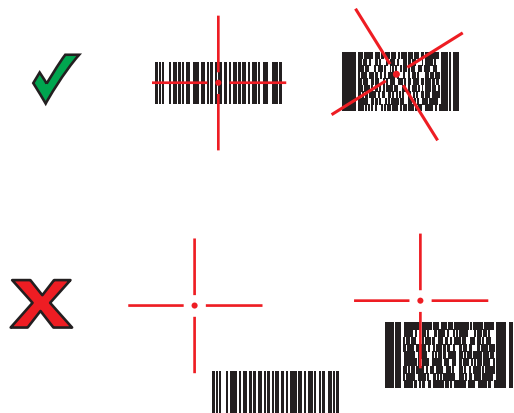

Figure 3-4 Imager Aiming Pattern



Figure 3-5 Pick List Mode with Multiple Bar Codes

3. Release the scan button.

✓ **NOTE** Imager decoding usually occurs instantaneously. The MC75A repeats the steps required to take a digital picture (image) of a poor or difficult bar code as long as the scan button remains pressed.

Color Digital Camera

MC75A with an integrated color digital camera have the following features:

- Omnidirectional reading of a variety of bar code symbologies, including the most popular linear, postal, PDF417, and 2D matrix code types.
- Advanced intuitive aiming for easy point-and-shoot operation.

Digital Camera Scanning

1. Ensure that a scan-enabled application is loaded on the MC75A.
2. Aim the camera lens on the back of the MC75A at a bar code.
3. Press and hold the scan button. A preview window appears on the display window with a red aiming reticle in the center. The Scan/Decode LED lights red to indicate that scanning is in process.

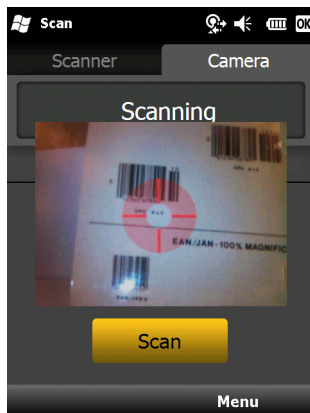

Figure 3-6 Sample Scan Application with Preview Window

4. Move the MC75A until the red aiming reticle is on the bar code to scan. The aiming reticle turns green when the MC75A is able to decode the bar code.

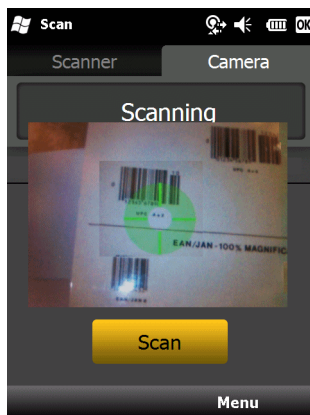

Figure 3-7 Digital Camera Scanning

5. Release the scan button. The Scan/Decode LED lights green and a beep sounds, by default, to indicate the bar code was decoded successfully.



NOTE The camera decode feature is set by default to automatically decode the bar code when read. This feature can be programmed to display a green aiming reticle upon good decode indicating that the bar code has been successfully decoded and to that the scan button may be released.

Chapter 4 Using the Phone

Introduction

Use the MC75A to make phone calls, set up speed dials, keep track of calls, and send text messages. Your wireless service provider may also provide other services such as voice mail, call forwarding, and caller ID.

Also use the integrated phone to connect to an ISP or work network in order to browse the Web and read e-mail. Connect to the Internet or work network over High-Speed Downlink Packet Access (HSDPA) (MC75A6) or Evolution Data-Optimized (EvDO) (MC75A8) using Cellular Line, or using the modem specified by the mobile operator. For more information, or to customize the MC75A phone by changing phone settings, see the *MC75A Integrator Guide*.

Accessing the Phone Keypad

- ✓ **NOTE** Keypads vary depending on the carrier, services and the state of the phone. For example, place calls on hold and use **Swap** to switch active calls on hold. (See [Conference Calling on an MC75A6 on page 4-19](#).)

Access the keypad regardless of the program in use. Applications on the MC75A can be in use during a call.

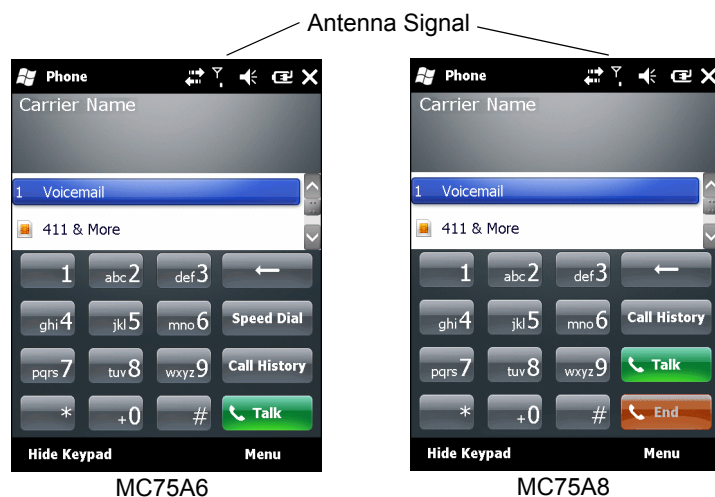

Figure 4-1 Phone Keypads

To access the phone keypad tap **Start** > **Phone** or press the green phone key on the MC75A's keypad.

To receive calls when the MC75A is suspended, leave the phone radio turned on and ensure the MC75A is set to wake with any key.

Turning the Phone On and Off

Windows Mobile 6 devices include **Wireless Manager**, which provides a simple method of enabling and disabling the phone.

To open **Wireless Manager**, tap the **Connectivity** icon.

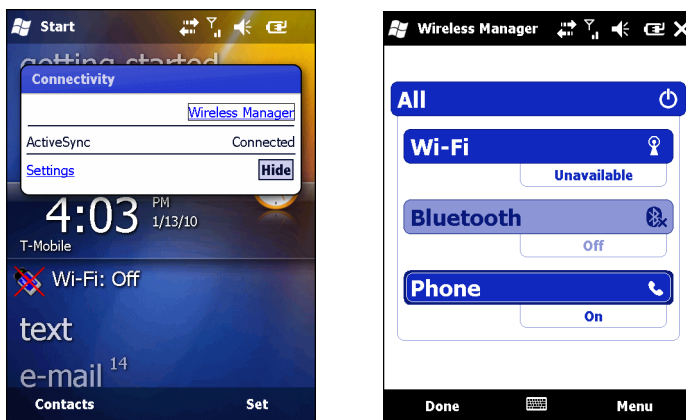

Figure 4-2 *Opening Wireless Manager*

Select **Wireless Manager**. The **Wireless Manager** window appears.

To toggle on or off the phone, tap blue Phone bar.

To configure settings for a connection, tap **Menu** > **Phone Settings**.

✓ **NOTE** To receive calls when your device is suspended, leave the phone turned on.

Audio Modes

The MC75A offers three audio modes for use during phone calls:

- **Handset Mode:** Switches audio to the speaker at the top front of the MC75, so you can use the MC75A as a handset. This is the default mode.
- **Speaker Mode:** Use the MC75A as if on speaker phone. Tap the **Speaker On** button to activate this mode. Tap the **Speaker Off** button to switch back to handset mode.
- **Headset Mode:** Connect a wired or Bluetooth headset to automatically switch audio to the headset.

The MC75A defaults to handset mode. When a wired headset is plugged into the MC75A audio connector or a Bluetooth headset is configured for use with the MC75, the earpiece and speakerphone are muted and audio is heard through the headset.

✓ **NOTE** While using a Bluetooth headset during a call, the mobile computer will not go into suspend mode.



Handset Mode

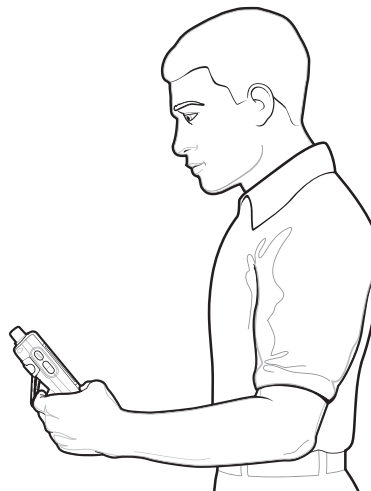

Speaker Mode



Headset Mode

Figure 4-3 Audio Modes

Using a Wired Headset

You can use a stereo headset for audio communication when using an audio-enabled application. To use a headset, plug the headset jack into the audio connector on the side of the MC75A. Set the MC75A's volume appropriately before putting the headset on. Plugging a headset into the jack mutes the speaker.

For the best audio performance, Zebra recommends a 2.5mm jack headset, see [Chapter 7, Accessories](#).

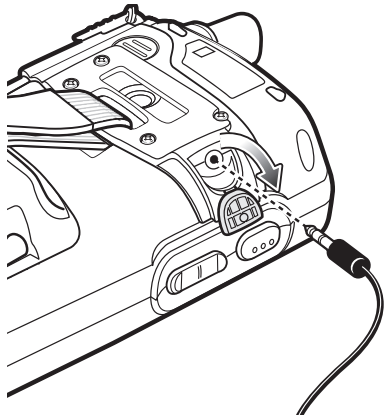

Figure 4-4 Using a Headset

Using a Bluetooth Headset

You can use a Bluetooth headset for audio communication when using an audio-enabled application. See [Chapter 6, Using Bluetooth](#) for information on connecting a Bluetooth headset to the MC75A. Set the MC75A's volume appropriately before putting the headset on. When a Bluetooth headset is connected the speakerphone is muted.

It is recommended for phone conversations to use the Bluetooth Hands-free profile instead of the Headset profile. See [Chapter 6, Using Bluetooth](#) for more information.

✓ **NOTE** When using a Bluetooth headset during a call, the MC75A power button is disabled and the MC75A will not go into suspend mode. Once the call is completed, the power button functionality is enabled.

The following dialog box displays when a Bluetooth headset connection is established.

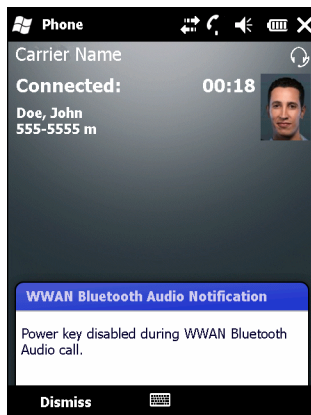

Figure 4-5 WWAN Bluetooth Audio Notification Dialog Box

Adjusting Audio Volume

Use the Volume Control Slider or the keypad keys to adjust the volume of the ringer when not in a call and the audio volume when in a call.

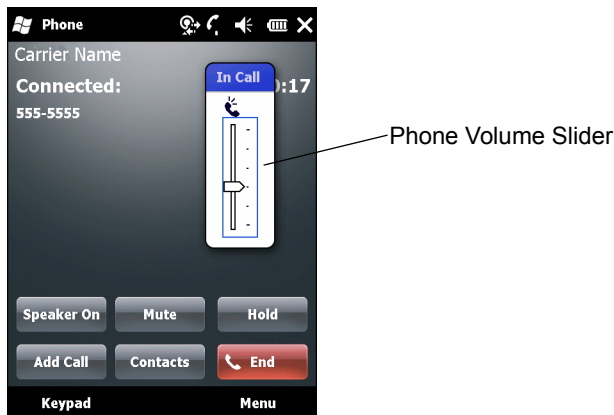

Figure 4-6 Phone Volume Slider

To adjust the volume tap the **Speaker** icon in the **Title** bar. Move the slider up or down to adjust the volume.

- ✓ **NOTE** Adjust the conversation phone volume during a call. Adjusting the volume while not in a call affects the ring and notification sound levels.

Making a Call

- ✓ **NOTE** You can make emergency calls even when the MC75A is locked or when a SIM card is not installed. See [Making an Emergency Call on page 4-7](#) for more information.

With the MC75A, you can make a call from the phone dialer, contacts, speed dial and call history.

Using the Phone Dialer

To make a call using the phone keypad:

1. Tap **Start** > **Phone** or press the green phone key on the MC75A's keypad.
2. From the **Phone** keypad, tap the number to call.
3. Tap **Talk**.
4. Tap **End** to stop dialing or end the call.

- ✓ **NOTE** Alternatively, use the green and red phone keys on the MC75A keypad to dial (green) and end (red) calls.

If you tap a wrong number, tap Delete key to erase each subsequent digit of a number. To erase the entire number, tap and hold the Delete key.

Using Contacts

Use Contacts to make a call without looking up or entering the phone number.

To make a call from Contacts:

1. Tap **Start** > **Contacts**.
2. From the contact list, tap and hold the contact name.

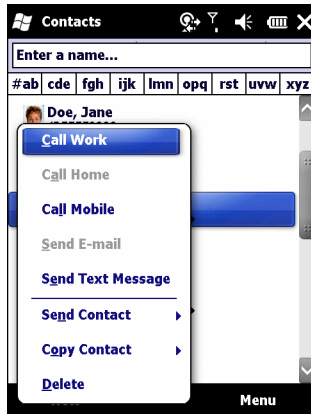

Figure 4-7 Contacts Menu

3. Tap **Call Work**, **Call Home** or **Call Mobile**.



NOTE To make a call from an open contact, tap the number to call. See On-Device Help for more information about Contacts.

Using Call History

To make a call using Call History:

1. Tap **Start > Phone** or press the green phone key on the MC75A's keypad.
2. From the Phone keypad, tap **Call History**.

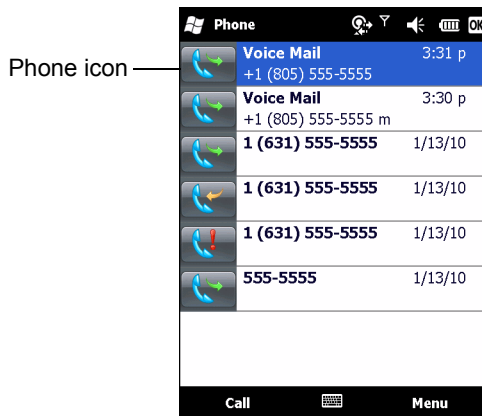

Figure 4-8 Call History Window

3. Tap the phone icon next to the number to begin dialing and return to the phone keypad.
4. Tap **End** or press the red phone key on the MC75A keypad to stop dialing or end the call.

Making a Speed Dial Call

Use Speed Dial to call someone saved in the speed dial directory.

To make a speed dial call:

1. Tap **Start > Phone** or press the green phone key on the MC75A's keypad.

- From the Phone keypad, tap and hold the speed dial location number assigned to a contact. (To dial a one-digit speed dial location number, tap and hold the speed dial number. To dial a two-digit speed dial location number, tap the first digit and then tap and hold the second digit.)

or

From the Phone keypad, tap **Speed Dial** and tap the speed dial location number of the desired contact in the list.

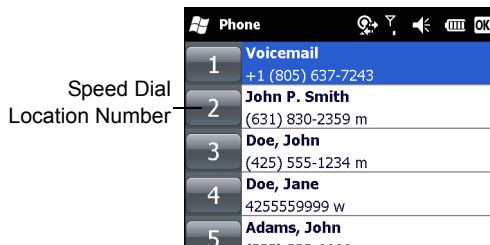

Figure 4-9 Speed Dial Contact List

- To stop dialing or end the call, tap **End** or press the red phone key on the MC75A keypad.

Making an Emergency Call

Your service provider programs one or more emergency phone numbers, such as 911 or 999, that you can call under any circumstances, even when your phone is locked or the SIM card is not inserted (on MC75A6). Your service provider can program additional emergency numbers into your SIM card. However, your SIM card must be inserted in your phone in order to use the numbers stored on it. See your service provider for additional information. See [Installing the SIM Card on page 1-3](#) for SIM card installation procedures.

When the alpha-numeric keypad phone is locked, press the Orange key twice to set the keypad to numeric mode and then enter the emergency number.

- ✓ **NOTE** Emergency numbers vary by country. Your phone's pre-programmed emergency number(s) may not work in all locations, and sometimes an emergency call cannot be placed due to network, environmental, or interference issues.

Answering a Call

A dialog box appears on the MC75A when it receives an incoming call. If the phone is set to ring, a ring tone sounds. Answer or ignore the incoming call.

To answer an incoming call tap **Answer** on the **Phone - Incoming** dialog or press the green phone key on the MC75A keypad.

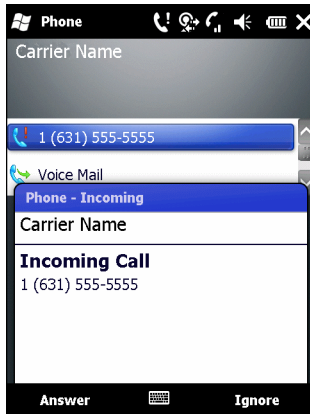

Figure 4-10 Incoming Call

To ignore the incoming call tap **Ignore**. This may send the caller to voice mail, depending on the service provider. Otherwise, this presents busy signal to the calling party.

To end the call tap **End** or press the red phone key on the MC75A keypad.

Incoming Call Features

- If you receive a call while in a call, tap **Wait** to place the call in call waiting.
- You can use other programs on the MC75A during a call. To switch back to Phone, tap **Talk** or tap **Start > Phone**. Tap **End** to end the call.
- If a caller isn't in your contact list, create a contact during the call or from Call History by tapping **Menu > Save to Contacts**.
- To terminate a call when a second call comes in and answer the waiting call, tap **End** on the Phone keypad to disconnect the active call, then tap **Answer** or press the **Send** key to answer the waiting call.
- To hold the current call and answer a waiting call, tap **Answer** or press the **Send** key to place the current call on hold and answer the incoming call.
- To put a call on hold to call another number or answer an incoming call, tap **Hold** on an MC75A6 or **Talk** on an MC75A8. To move from one call to another, tap **Swap** on an MC75A6 or **Talk** on an MC75A8.

Smart Dialing

Smart Dialing makes it easy to dial a phone number. When you start entering numbers or characters, Smart Dialing automatically searches and sorts the contact entries on the SIM card, in Contacts, and the phone numbers in Call History (including incoming, outgoing, and missed calls). You can then select the desired number or contact from the filtered list to dial.

Open the Phone screen, then tap the keys on the Phone keypad that correspond to the phone number or contact to call. The contact panel lists contacts that match the sequence that you entered.

Smart Dialing starts looking for numbers or contacts that match the sequence entered.

To find a phone number:

- Enter the first one or two digits to find a phone number in Call History.
- Enter the first three digits or more to find a phone number from the saved Contacts and SIM card.

To find a contact name:

- Enter the first letter of a contact's first name or last name. Smart Dialing searches for the letter starting from the first character of a contact name as well as from the character that appears after a space, dash, or underscore in a contact name. For example, if you tap number "2" which is associated with [a, b, c] on the Phone keypad, contact names such as the following will be considered matches: "Smith, Bernard", "Adams, John", "Carlson, Eileen", "Dillon, Albert", "Childs, Larry", "Cooper, Robert" and "Parks, Celine".
- If the matching list is long narrow down the search further by entering another letter. Using the same example above, tap "3" which is associated with (d, e, f), the matching list is narrowed down to the following names: "Smith, Bernard", "Adams, John", and "Parks, Celine".

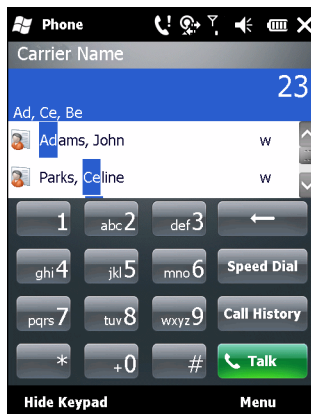

Figure 4-11 Finding a Contact

To make a call or send a text message using Smart Dialing:

1. Begin entering the first few numbers or characters.
2. In the Smart Dialing panel, use the up and down arrows on the keypad to navigate to the desired contact or phone number.
3. When the correct contact is selected, press **TALK** to make a voice call.
4. To send a text message to the selected contact, tap **Menu > Send Text Message**.
5. To call a different phone number associated with the selected contact, tap the contact name and select the phone number to call.

Muting a Call

During a call, you can mute the microphone so you can hear the person on the line but he or she cannot hear conversation from the microphone. This is useful when there is conversation or background noise on your end.

To mute or unmute a call:

1. Tap **Start > Phone** or press the green phone key on the MC75A's keypad.
2. Make a call.
3. Tap **Mute** on the display to mute the audio. The **Mute** icon appears.

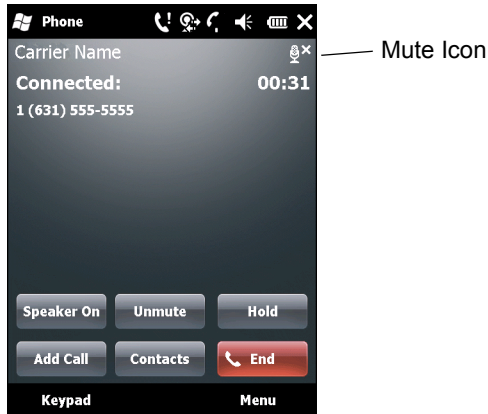

Figure 4-12 Mute Button and Icon

Taking Notes

To create a note during a call, tap **Note** on the display, then enter the note. For more information about creating notes see the Windows On-Device Help.

To access a note created during a call:

1. Tap **Start** > **Phone** or press the green phone key on the MC75A's keypad.
2. From the Phone keypad, tap **Call History**.
3. Tap and hold the number or the **Note** icon for the phone call entry containing the note.

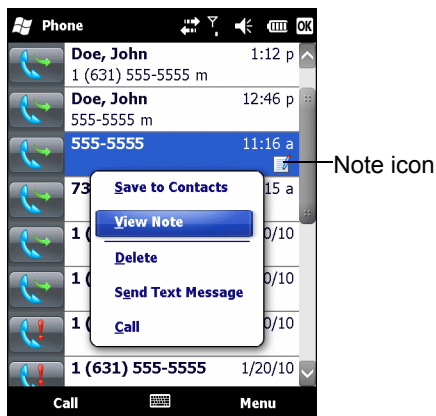

Figure 4-13 Call History - Notes Menu

4. Tap **View Note**.
5. Tap **OK** to exit.



NOTE Also access notes directly from the Notes application by tapping **Start** > **Notes**.

Using Speed Dial

Create speed dial numbers to dial frequently called numbers with a single tap. Before creating a speed dial entry, ensure the phone number exists in Contacts.

Adding a Speed Dial Entry

To add a speed dial entry from the phone keypad:

1. Ensure the contact and phone number are in the Contacts list.
2. Tap **Start > Phone** or press the green phone key on the MC75A's keypad.
3. Tap **Speed Dial** button > **Menu > New**.



Figure 4-14 *Contacts*

4. Tap the desired contact name and number in the list.

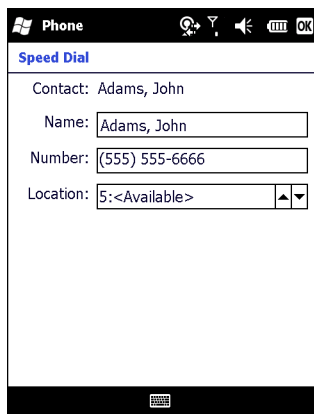

Figure 4-15 *Speed Dial Contact Location*

5. In the **Location** field, tap the up/down arrows to select an available location to assign as the new speed dial entry. The first speed dial location is reserved for voice mail.
6. Tap **OK** to add the contact to the speed dial list.

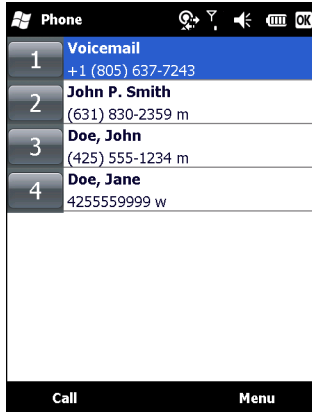

Figure 4-16 Speed Dial Contact List

7. Tap **OK** to exit the **Speed Dial Contact List**.

To add a speed dial entry from the **Contacts** window:

1. Tap **Start > Contacts**.

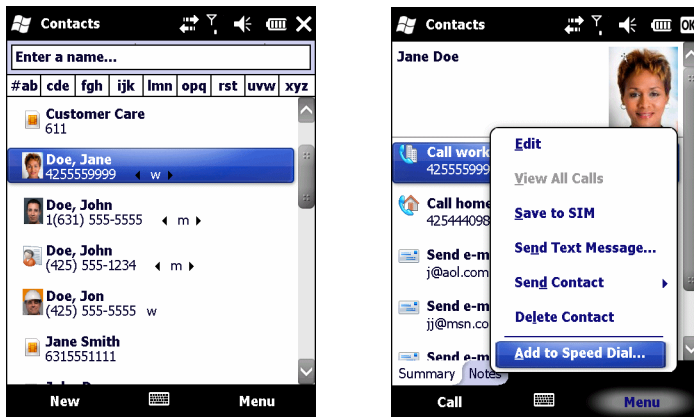

Figure 4-17 Contacts

2. Tap a contact name.

3. Tap **Menu > Add to Speed Dial**.

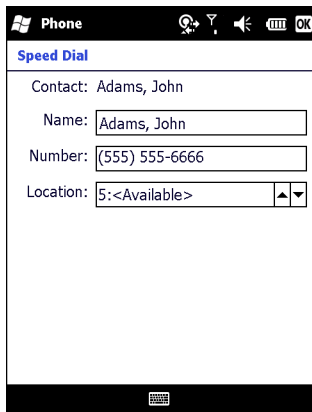

Figure 4-18 Speed Dial Contact Location

4. Tap the up/down arrows to select an available location to assign as the new speed dial entry. The first speed dial location is reserved for voice mail.
5. Tap **OK**.

Editing a Speed Dial Entry

1. Tap **Start** > **Phone** or press the green phone key on the MC75A's keypad.
2. Tap **Speed Dial** button.

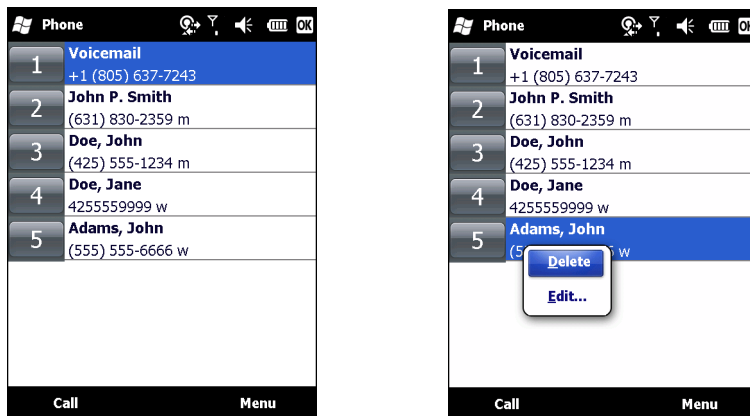

Figure 4-19 Speed Dial Contact List

3. Tap and hold the contact name.
4. Tap **Edit...**
5. Change the name, phone number, or location information.
6. Tap **OK**.

✓ **NOTE** Editing names and phone numbers in **Speed Dial** does not alter contact information in **Contacts (Start > Contacts)**.

Deleting a Speed Dial Entry



1. Tap **Start** > **Phone** or press the green phone key on the MC75A's keypad.
2. Tap **Speed Dial** button.
3. Tap and hold the contact name.
4. Tap **Delete**.
5. Tap **Yes** to confirm permanently deleting the speed dial entry.

✓ **NOTE** Deleting names and phone numbers in *Speed Dial* does not delete the contact information in **Contacts (Start > Contacts)**.

Using Call History

Use Call History to call someone who was recently called, or recently called in. Call History provides the time and duration of all incoming, outgoing, and missed calls. It also provides a summary of total calls and easy access to notes taken during a call. [Table 4-1](#) lists the call history icons that appear in the **Call History** window.

Table 4-1 *Call History Icons*

Icon	Description
	This icon appears next to the contact information for all outgoing calls.
	This icon appears next to the contact information for all incoming calls.
	This icon appears next to the contact information for all missed calls.

Managing Call History

Change views, reset the call timer, and delete calls to manage the calls stored in Call History.

Changing the Call History View

1. Tap **Start** > **Phone** or press the green phone key on the MC75A's keypad to display the Phone keypad.
2. From the Phone keypad, tap **Call History**.
3. Tap **Menu** > **Filter** to show the menu.

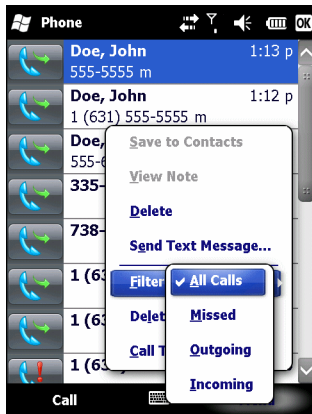

Figure 4-20 *Call History - All Calls/Show Menu*

4. Select a view type from the menu to display only missed calls, outgoing calls, incoming calls, or calls listed alphabetically by caller name.
5. Tap **OK** to exit the **Call History** window.

Resetting the Recent Calls Counter

1. Tap **Start** > **Phone** or press the green phone key on the MC75A's keypad to display the Phone keypad.
2. From the Phone keypad, tap **Call History**.
3. Tap **Menu**.

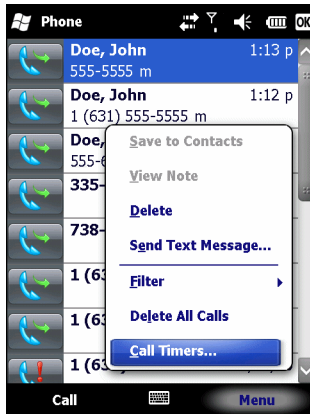

Figure 4-21 Call History - Tools Menu

4. Select Call Timers...

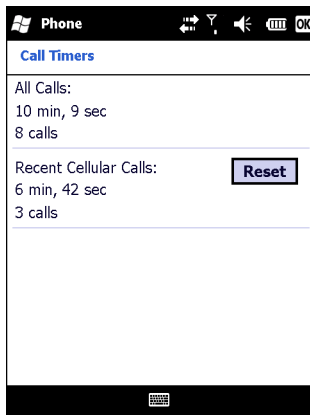

Figure 4-22 Call History - Call Timers

5. Tap **Reset**. (The **All Calls:** counter cannot be reset.)
6. Tap **OK** to exit the **Call Timers** window.

Deleting All Call History Items

1. Tap **Start > Phone** or press the green phone key on the MC75A's keypad to display the Phone keypad.
2. From the Phone keypad, tap **Call History**.
3. Tap **Menu**.

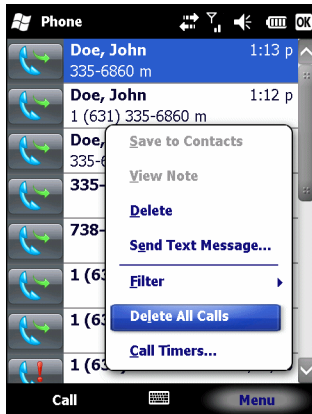

Figure 4-23 Call History - Tools Menu

4. Select *Delete all calls*.

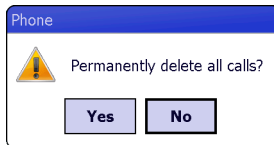

Figure 4-24 Call History - Delete All Dialog

5. Tap **Yes**.
6. Tap **OK** to exit the **Call History** window.

Viewing Call Status

1. Tap **Start** > **Phone** or press the green phone key on the MC75A's keypad to display the Phone keypad.
2. From the Phone keypad, tap **Call History**.
3. Tap an entry. The Call Status window appears.

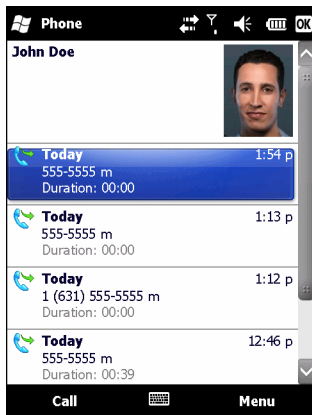

Figure 4-25 Call History - Detail



NOTE When more than one call is on the phone line, only the duration of the first call is recorded.

4. Tap **OK** and then **OK** to exit.

Using the Call History Menu

Use the Call History menu to dial voice mail, access the Activation Wizard, save to contacts, view a note, delete a listing, send a text message, and make a call.

1. Tap **Start** > **Phone** or press the green phone key on the MC75A's keypad to display the Phone keypad.
2. From the Phone keypad, tap **Call History**.
3. Tap and hold an item in the list.

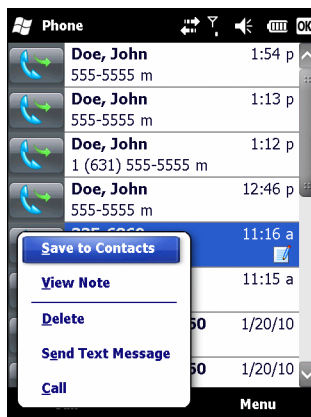

Figure 4-26 Call History - Menu

4. Select an applicable item from the menu, as needed.
5. Depending on the item selected, the appropriate window displays. For example, select **Send Text Message** to display the **Inbox** window.
6. Tap **OK** to exit the **Call History** window.

Swapping Calls on an MC75A6

To move between two phone calls:

1. Tap **Start** > **Phone** or press the green phone key on the MC75A's keypad to display the Phone keypad.
2. Enter the first phone number and press **Talk**. When the call connects, **Hold** appears on the keypad.

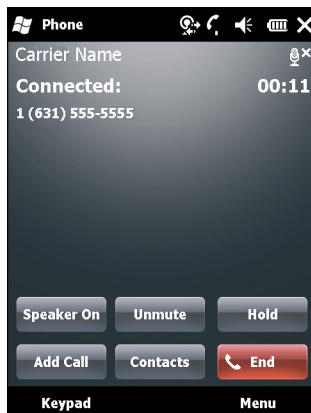

Figure 4-27 Call Swapping - Hold

3. Tap **Hold** on to place the first number on hold.
4. Enter the second number and tap **Talk**.

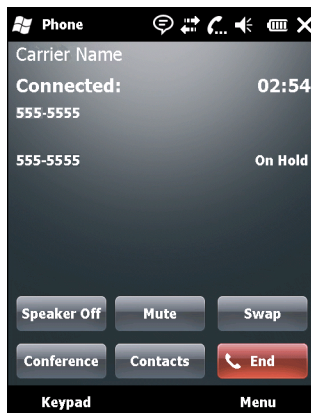

Figure 4-28 Call Conferencing - Conferencing

5. Tap **Swap** to move from one call to the other.
6. Tap **End** or press the red phone key on the MC75A keypad to end each call.

Swapping Calls on an MC75A8

To swap between two incoming phone calls:

1. Tap **Answer** to connect to the first call.

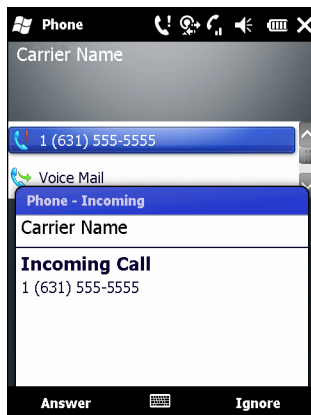

Figure 4-29 Answer a Call

2. When a second call arrives, tap **Answer**. The first call is placed on hold.
3. Tap **Talk** to swap from one call to the other.

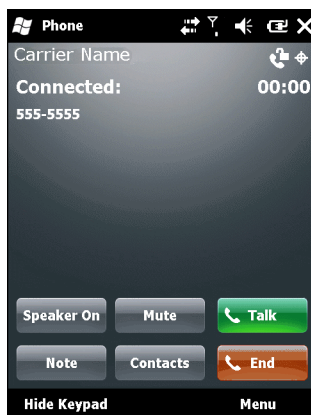

Figure 4-30 Call Swapping

4. Tap **End** or press the red phone key on the MC75A keypad to end active call. The remaining call re-connects, tap **Answer** to connect to the call.
5. Tap **End** or press the red phone key on the MC75A keypad to end the last call.

Conference Calling on an MC75A6

- ✓ **NOTE** Conference Calling and the number of conference calls allowed may not be available on all services. Please check with your service provider for Conference Calling availability.

To create a conference phone session with multiple people:

1. Tap **Start > Phone** or press the green phone key on the MC75A's keypad to display the Phone keypad.
2. Enter the first phone number and press **Talk**. When the call connects, **Hold** appears on the keypad.

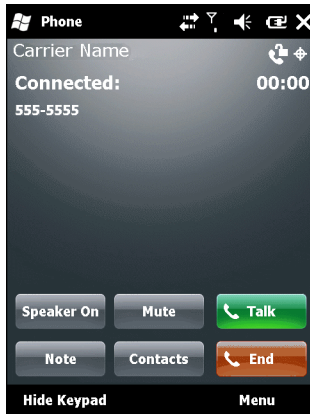

Figure 4-31 Conference Call - Hold

3. Tap **Hold** to place the first call on hold.
4. Enter the second phone number and tap **Talk**.
5. After the call is answered, tap **Menu** > **Conference** to place the calls in conference mode.

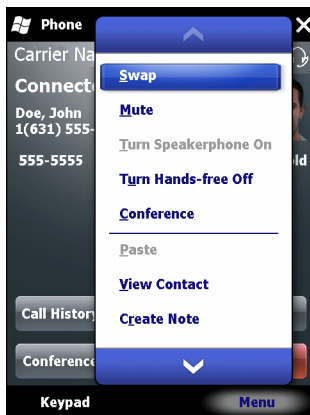

Figure 4-32 Creating a Conference Call

6. Tap **Hold** to place the conference on hold.
7. Enter another phone number and tap **Talk**.
8. After the call is answered, tap **Menu** > **Conference** to place all the calls in conference mode.
9. Repeat steps 6 through 8 for up to six phone numbers.
10. Tap **End** or press the red phone key on the MC75A keypad to end the conference call.

✓ **NOTE** To speak privately with one party during a conference call, tap **Menu** > **Private**. To include all parties again, tap **Menu** > **Conference**.

Three-way Calling on an MC75A8

✓ **NOTE** Three-way Calling may not be available on all services. Please check with your service provider for availability.

To create a three-way phone session with two people and you as the initiator:

1. Tap **Start** > **Phone** or press the green phone key on the MC75A's keypad to display the Phone keypad.
2. Enter the first phone number and press **Talk**.
3. To call a second person, tap **Keypad**. Enter the second number and tap **Talk**.

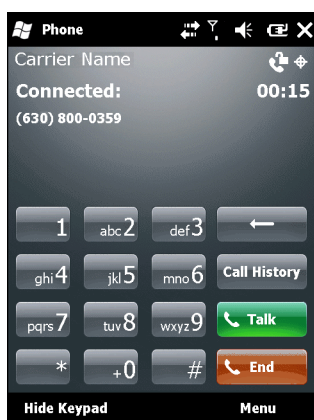

Figure 4-33 *Calling Another Person*

4. When the second person answers the call, tap **Talk** to create a three-way calling session.
5. Tap **Talk** to drop the last call.
6. Tap **End** to drop the first call.

Text Messaging

Use the **Text Messages** window to send and receive text messages to and from mobile phones. The text can contain words, numbers, or an alphanumeric combination no longer than 160 characters.

Short text messages delivered over mobile networks transmit from the sending MC75A, are stored in a central short message center, then forwarded to the destination mobile device. If the recipient is not available, the message is stored and can be sent later.

Viewing Text Messages

To view a text message:

You can view a text message whether the phone is on or off. When the phone is on, you can view a text message from its notification callout. Tap the **text message notification** icon on the navigation bar to display the message.

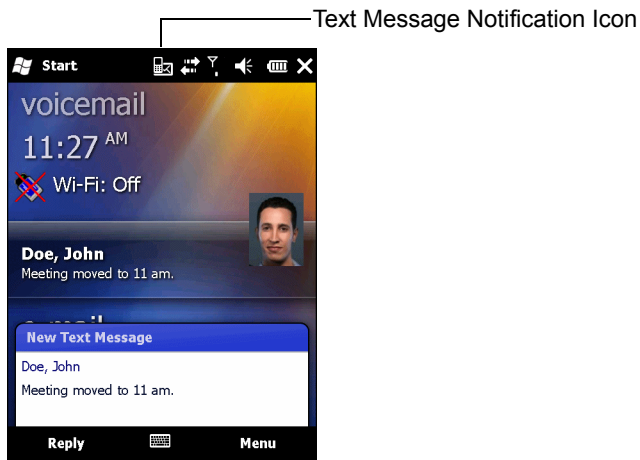

Figure 4-34 *New Text Message Notification*

The Caller Identification feature matches incoming text message numbers with those stored in **Contacts** so you know who is sending you a message. Furthermore, the **New Text Message** dialog box gives you the option to call the sender or save, dismiss, or delete the message.

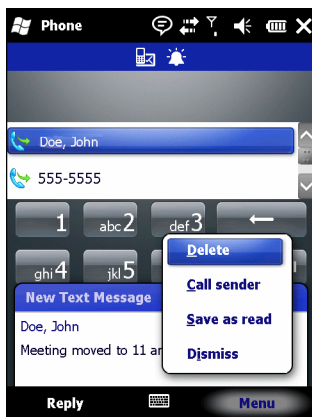

Figure 4-35 *New Text Message Options*

When the phone function is off, you can still view received text message in Messaging:

1. Tap **Start > Text** or on the Today screen, tap the text message on the Information Bar.

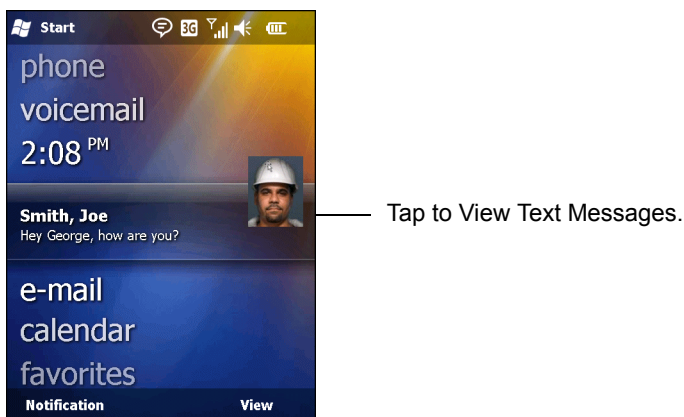

Figure 4-36 *Text Messaging on Today Screen*

2. The **Text Messages** window appears.
3. In the message list, tap the text message.

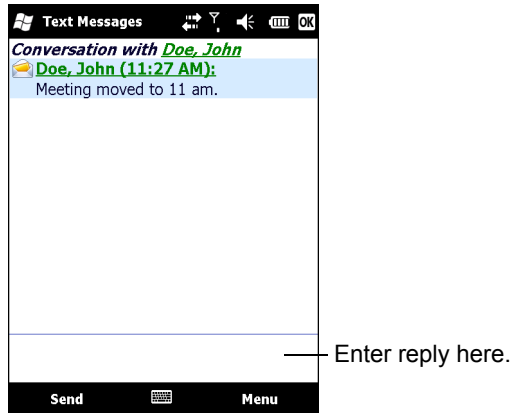

Figure 4-37 Text Messages List



NOTE If the phone is turned off and you tried to call the sender, send a reply, or forward the message, you are prompted to turn the phone function on.

Sending a Text Message

To create a text message:

1. On the **Phone** screen, select a contact name that you want to send a message to.
2. Tap **Menu > Send Text Message**.

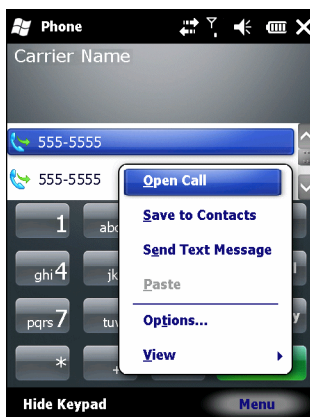

Figure 4-38 Phone Screen Contact List

3. Compose your message.

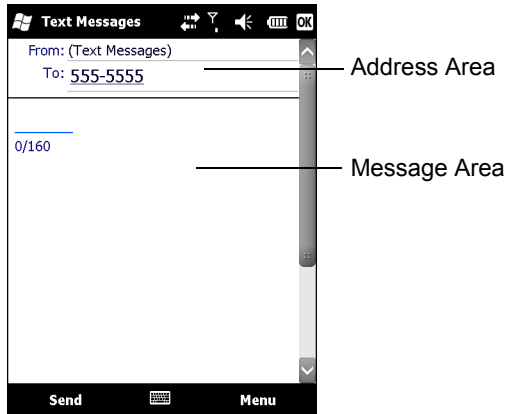

Figure 4-39 Create Text Message

- The auto-correct feature automatically fixes common spelling errors as you type so your messages are more accurate.
 - The character counter lets you see and control the size of the message as you compose.
 - If you want to know if your text message was received, tap **Menu > Message Options**, then select the **Request message delivery notification** check box.
4. Tap **Send** when you've finished the message.
- If the phone is turned on, your text message is sent. If it's off, you are prompted to turn on the phone. If you do so, the message is sent; otherwise when you tap **OK**, the message is saved in the **Drafts** folder and sent when the phone is turned on.
- If you are out of coverage area, the message is saved in the **Drafts** folder and sent when you return to a coverage area.

✓ **NOTE** On MC75A6 devices, the message remains in the **Drafts** folder and has to be manually re-sent when you return to a coverage area.

Using a Dual Line SIM

✓ **NOTE** Dual Line SIM support is only available on MC75A6 configurations.
Check with your service provider for availability.

Dual line SIM cards allow for two phone lines on a single card. For example, one line can be a business phone line and the other a personal phone line.

To switch between phone lines:

1. Tap **Start > Programs > SIM Toolkit**.

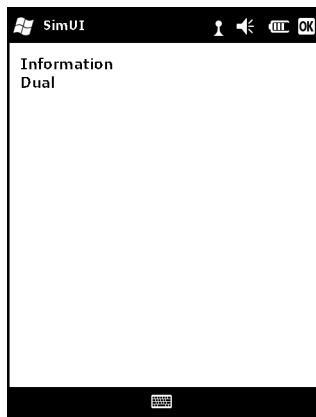

Figure 4-40 SIM UI Window

2. Select **Dual** and then tap **Select**.

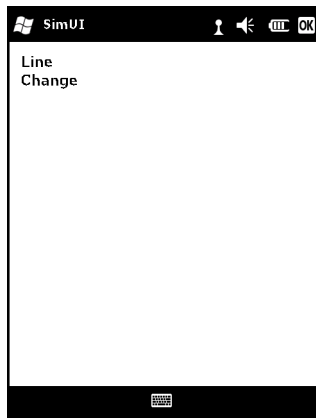

Figure 4-41 Change Phone Line

3. Select **Change** and then tap **Select**.
4. If applicable, sign in with the PIN number for the other line.

Chapter 5 Using GPS Navigation

Introduction

The MC75A includes Global Positioning System (GPS) technology using the SiRF III chipset. GPS technology is based on a worldwide system of GPS satellites orbiting the earth that continuously transmit digital radio signals. These radio signals contain data on the satellites' locations and their exact clock time and are used to determine your location on the earth.



WARNING! When using the MC75A in a vehicle, it is the user's responsibility to place, secure and use in a manner that will not cause accidents, personal injury or property damage or obstruct their view. It is the responsibility of the driver to operate the vehicle in a safe manner, maintain observation of all driving conditions at all times, and not become distracted by the device to the exclusion of safe driving practices. It is unsafe to operate the controls of the device while driving.

Software Installation

Third-party GPS navigation software is required. Evaluation software is available from various suppliers. For example; VisualGPS, visit: <http://www.visualgps.net/VisualGPSce/>

If interested in purchasing GPS navigation software check with the GPS software vendor (before purchasing, downloading, or installing any software) to determine that the application is compatible with the MC75A. Refer to the application's user guide for application installation and setup information.

MC75A GPS Setup

By default, the MC75A has the following settings:

1. Tap **Start > Settings > System > External GPS** icon.
2. In the **Programs** tab, the **GPS program port** is set to **COM8**.
3. In the **Hardware** tab, the **GPS hardware port** is set to **GMX1**.

Multiple programs can simultaneously access GPS data. Each program must use Microsoft GPS API or COM8 to access the GPS data.

Operation

Acquiring satellite signals may take several seconds to a few minutes. It is best to be outside and have a clear, unobstructed view of the sky. Without a clear view, acquisition takes much longer and could result in the MC75A being unable to compute the initial position quickly. When operating the device indoors access to the GPS signals may be limited or unavailable.

- ✓ **NOTE** When using a GPS navigation application, ensure that the MC75A does not go into suspend mode. If the MC75A suspends then the power to the GPS radio is removed. Upon resume the GPS receiver must reacquire a valid GPS signal, resulting in a delay of positional information.

GPS Maps on microSD Cards

GPS navigation software vendors may sell maps on microSD cards. If using a microSD card with the GPS navigation software:

1. Remove the Memory Card Cover on the side of the MC75A.
2. Insert the microSD card into the slot.
3. Replace the Memory Card Cover.

Answering a Phone Call While Using GPS

If you receive a phone call while using your GPS navigation software:

1. Answer the phone call by pressing the **Answer** button.
2. Once you end the phone call, press the **End Call** button to resume the audio on the GPS software.

- ✓ **NOTE** Anytime you are using GPS on the MC75A and you receive a phone call, the audio on the GPS navigation software is muted until you finish the call.

Losing the GPS Signal While in a Vehicle

GPS performance on the MC75A may be affected if the vehicle has thermal glass windows and windshields, which can block the MC75A from receiving a GPS signal from satellites. To improve GPS signal strength, place the MC75A where there is a clear view of the sky. A direct line of sight is required between the MC75A and the GPS satellites to access information from the satellites.

The Global Positioning System (GPS) is a system that allows the user to track their position anywhere on the earth.

Assisted GPS

GPS can be used in stand-alone or Assisted GPS (A-GPS) modes. A Stand-alone GPS receiver downloads data from GPS satellites. It can take several minutes to get a fix. By using GPS Location servers, A-GPS dramatically improves the performance of the Time To First Fix (TTFF) of GPS receivers by providing them with data that they would ordinarily have to download from the GPS satellites and other aiding data that helps the acquisition. With the A-GPS data, GPS receivers can operate faster and more reliably.

A-GPS follows the Secure User Plane Location (SUPL) protocol which allows the MC75A to communicate with a location server.

To configure SUPL on the MC75A:

1. Tap **Start > Settings > System > GPS Setup** icon.

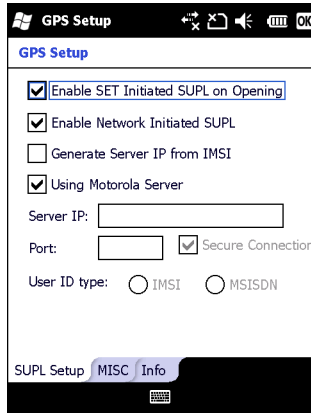

Figure 5-1 SUPL Setup Tab

2. Select **Enable SET Initiated SUPL on Opening** to enable the MC75A to initiate SUPL upon opening the GPS port.
3. Select **Enable Network Initiated SUPL** to enable the network to initiate SUPL.
4. Select **Generate Server IP from IMSI** to automatically generate the server IP address from the IMSI (on GSM WAN devices only) or select **Using Motorola Server** to use the SUPL server.
5. Enter the SUPL Server IP address in the **Server IP** field. The server IP address is not required when generating the server IP address from the IMSI or when using the Motorola server.
6. Enter the SUPL Server port number in the **Port** field. The port number is not required when using the Motorola server.
7. Select **Secure Connection** to enable the TLS connection between the MC75A and the server. This option is not available when using the Motorola server.
8. **User ID type** is to choose which ID type to use during the SUPL session. This option is not available when using the Motorola server.

Use the **MISC** tab to enable Smart Re-aiding and Timing Control on Opening. These options are only available when **Enable SET Initiated SUPL on Opening** is enabled on the **SUPL Setup** tab.

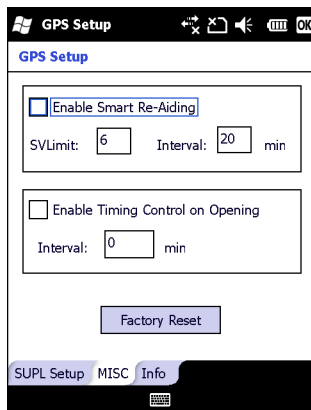

Figure 5-2 MISC Tab

Smart Re-Aiding causes the MC75A to reconnect to the SUPL server and download new A-GPS data if there are satellites in view and the number of satellites in use fall below the **SVLimit** value and the length of time passed since the last SUPL session is more than the value set in the **Interval** field.

Timing Control on Opening determines whether a SUPL session is established when the GPS port is opened. If the length of time passed since the last successful SUPL session is less than the set interval, a SUPL session is not established when the GPS port is opened.

Tap the **Factory Reset** button to perform a factory reset on the GPS chip.

Chapter 6 Using Bluetooth

Introduction

Bluetooth-equipped devices can communicate without wires, using frequency-hopping spread spectrum (FHSS) radio frequency (RF) to transmit and receive data in the 2.4 GHz Industry Scientific and Medical (ISM) band (802.15.1). Bluetooth wireless technology is specifically designed for short-range (30 feet/10 meters) communication and low power consumption.

MC75As with Bluetooth capabilities can exchange information (e.g., files, appointments, and tasks) with other Bluetooth enabled devices such as phones, printers, access points, and other mobile computers. To use the MC75A as a modem, create a dial-up modem connection between a computer and MC75A.

The MC75A with Bluetooth technology uses either the StoneStreet Bluetooth stack or the Microsoft Bluetooth stack. To write an application that uses the StoneStreet One Bluetooth stack APIs, refer to the Enterprise Mobility Developer Kit (EMDK) Help.

Adaptive Frequency Hopping

Adaptive Frequency Hopping (AFH) is a method of avoiding fixed frequency interferers, and can be used with Bluetooth voice. All devices in the piconet (Bluetooth network) must be AFH-capable in order for AFH to work. There is no AFH when connecting and discovering devices. Avoid making Bluetooth connections and discoveries during critical 802.11b communications. AFH for Bluetooth consists of four main sections:

- Channel Classification - A method of detecting an interference on a channel-by-channel basis, or pre-defined channel mask.
- Link Management - Coordinates and distributes the AFH information to the rest of the Bluetooth network.
- Hop Sequence Modification - Avoids interference by selectively reducing the number of hopping channels.
- Channel Maintenance - A method for periodically re-evaluating the channels.

When AFH is enabled, the Bluetooth radio “hops around” (instead of through) the 802.11b high-rate channels. AFH coexistence allows Zebra mobile computers to operate in any infrastructure.

The Bluetooth radio in this MC75A operates as a Class 2 device power class. The maximum output power is 2.5mW and the expected range is 32.8 feet (10 meters). A definition of ranges based on power class is difficult to obtain due to power and device differences, and whether one measures open space or closed office space.

✓ **NOTE** It is not recommended to perform Bluetooth wireless technology inquiry when high rate 802.11b operation is required.

Security

The current Bluetooth specification defines security at the link level. Application-level security is not specified. This allows application developers to define security mechanisms tailored to their specific need. Link-level security occurs between devices, not users, while application-level security can be implemented on a per-user basis. The Bluetooth specification defines security algorithms and procedures needed to authenticate devices, and if needed, encrypt the data flowing on the link between the devices. Device authentication is a mandatory feature of Bluetooth while link encryption is optional.

Pairing of Bluetooth devices is accomplished by creating an initialization key that is used to authenticate the devices and create a link key for them. Entering a common PIN number in the devices being paired generates the initialization key. The PIN number is never sent over the air. By default, the Bluetooth stack responds with no key when a key is requested (it is up to user to respond to the key request event). Authentication of Bluetooth devices is based-upon a challenge-response transaction. Bluetooth allows for a PIN number or passkey that is used to create other 128-bit keys used for security and encryption. The encryption key is derived from the link key used to authenticate the pairing devices. Also worthy of note is the limited range and fast frequency hopping of the Bluetooth radios that makes long-distance eavesdropping difficult.

Recommendations are:

- Perform pairing in a secure environment
- Keep PIN codes private and don't store the PIN codes in the mobile computer
- Implement application-level security.

The Microsoft stack supports Smart-pairing. For detailed information, refer to the Microsoft MSDN.

The StoneStreet One Bluetooth stack supports Secure Simple Pairing. Secure Simple Pairing improves the pairing experience for Bluetooth devices and increasing the use and strength of security. Both the host and the remote device must support Secure Simple Pairing. If one device does not, standard pairing will be used, as described above.

Bluetooth Configuration

By default, the MC75A is configured to using the Microsoft Bluetooth stack. Refer to the *MC75A Mobile Computer Integrator Guide*, Appendix B, for information on switching to the StoneStreet One Bluetooth stack.

Table 6-1 list the services supported by the Microsoft Bluetooth stack and the StoneStreet One Bluetooth stack.

Table 6-1 *Bluetooth Services*

Microsoft Bluetooth Stack	StoneStreet One Bluetooth Stack
OBEX Object Push Services	OBEX Object Push Services
Hands-Free Audio Gateway Services	Hands-Free Audio Gateway Services
Serial Port Services	Serial Port Services
Personal Area Networking Services	Personal Area Networking Services
PBAP Services	IrMC Services
Dial-Up Networking Services	Dial-Up Networking Services
HID Client Services	HID Client Services
A2DP/AVRCP Services	A2DP/AVRCP Services
	File Transfer Services
	Headset Audio Gateway Services

Table 6-2 list the COM ports available for the Microsoft Bluetooth stack and the StoneStreet One Bluetooth stack.

Table 6-2 *COM Ports*

Microsoft Bluetooth Stack	StoneStreet One Bluetooth Stack
COM5	COM5
COM9	COM9
	COM11
	COM21
	COM22
	COM23

Bluetooth Power States

Cold Boot

With StoneStreet One Bluetooth Stack

Performing a cold boot on the MC75A turns off Bluetooth after initialization (which takes a few moments). It is normal to see the **Bluetooth** icon appear and disappear (when using the Classic Home screen), as well as a wait cursor, when initialization proceeds in all modes.

With Microsoft Bluetooth Stack

Performing a cold boot retain the state of the Bluetooth radio prior to the cold boot.

Warm Boot**With StoneStreet One Bluetooth Stack**

Performing a warm boot on the MC75A turns off Bluetooth.

With Microsoft Bluetooth Stack

Performing a warm boot retain the state of the Bluetooth radio prior to the warm boot.

Suspend

When there is an active Bluetooth connection, the Bluetooth radio goes into low power mode maintaining the active connection. When there is no active connection, the Bluetooth radio turns off.

With StoneStreet One Bluetooth Stack

- ✓ **NOTE** If there is an active Bluetooth connection between the MC75A and another Bluetooth device, the MC75A will not timeout. However, if the user presses the Power button on the MC75A, the MC75A will suspend (except when on a call) and upon receiving data from a remote Bluetooth device, the MC75A will wake from suspend mode. For example, headset redial or Bluetooth scanner sending data to the MC75A.

With Microsoft Bluetooth Stack

- ✓ **NOTE** If there is an active Bluetooth connection between the MC75A and another Bluetooth device and there is no data activity, the MC75A will timeout. However, if the user presses the Power button on the MC75A, the MC75A will suspend (except when on a call) and upon receiving data from a remote Bluetooth device, the MC75A will wake from suspend mode. For example, headset redial or Bluetooth scanner sending data to the MC75A.

Resume

When the MC75A resumes, Bluetooth turns on if it was on prior to suspend.

Using Microsoft Bluetooth Stack

The following sections provide information on using the Microsoft Bluetooth stack.

Turning the Bluetooth Radio Mode On and Off

Turn off the Bluetooth radio to save power or if entering an area with radio restrictions (e.g., an airplane). When the radio is off, other Bluetooth devices cannot see or connect to the MC75A. Turn on the Bluetooth radio to exchange information with other Bluetooth devices (within range). Communicate only with Bluetooth radios in close proximity.

- ✓ **NOTE** To achieve the best battery life turn off radios not in use.

Enabling Bluetooth

To enable Bluetooth:

1. Tap **Wireless Manager** and then tap the **Bluetooth** bar or
Tap **Start > Setting > Connections > Bluetooth icon > Mode** tab.

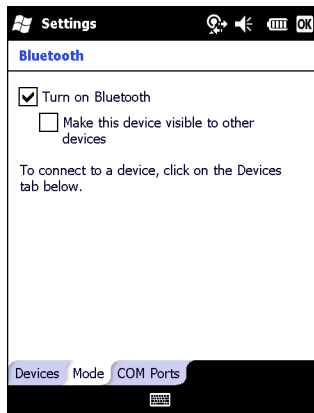

Figure 6-1 *Bluetooth Mode Tab*

2. Check the **Turn On Bluetooth** checkbox.
3. Tap **OK**.

Disabling Bluetooth

To disable Bluetooth:

1. Tap **Wireless Manager** and then tap the **Bluetooth** bar or
Tap **Start > Setting > Connections > Bluetooth icon > Mode** tab.
2. Un-check the **Turn On Bluetooth** checkbox.
3. Tap **OK**.

Discovering Bluetooth Device(s)

The MC75A can receive information from discovered devices without bonding. However, once bonded, the MC75A and a bonded device exchange information automatically when you turn the Bluetooth radio on. See [Bonding with Discovered Device\(s\) on page 6-32](#) for more information.

To find Bluetooth devices in the area:

1. Ensure that Bluetooth is enabled on both devices.
2. Ensure that the Bluetooth device to discover is in discoverable and connectable modes.
3. Ensure that the two devices are within 30 feet (10 meters) of one another.
4. Tap **Start > Settings > Connections tab > Bluetooth icon > Devices** tab.

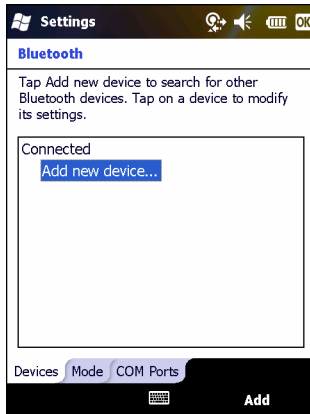

Figure 6-2 Bluetooth - Devices Tab

5. Tap **Add new device**. The MC75A begins searching for discoverable Bluetooth devices in the area.

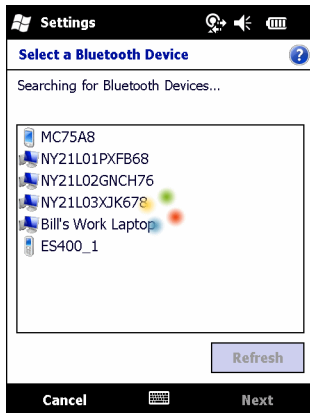

Figure 6-3 Searching for Bluetooth Devices

6. Select a device from the list.

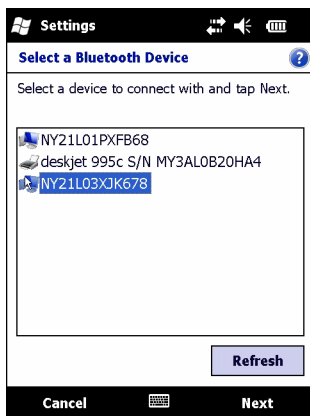

Figure 6-4 Select a Bluetooth Device

7. Tap **Next**. The **Enter Passcode** window appears.



NOTE If Smart-pairing is configured and the device is requesting one of the pre-defined PINs, the **Enter Passcode** window does not appear.

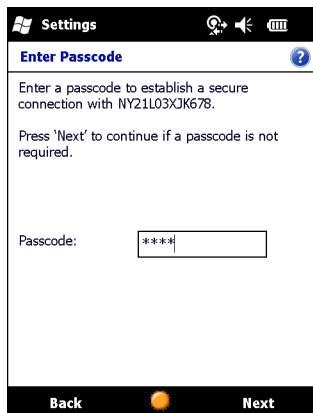

Figure 6-5 *Enter Passcode*

8. Enter the Passcode on the other device. The device is added to the Bluetooth list.



Figure 6-6 *Bluetooth Connection Confirmation*

You are prompted to enter a passcode. If the device has a specific passcode, enter it in the Passcode field and tap **Next**. If the device does not have a specific passcode, enter a passcode in the Passcode field and tap **Next**. The Bluetooth radio tries to connect with the device.

9. If you created a passcode, you will be prompted by the other device to enter the same passcode. Enter the created passcode to establish a paired connection. (If you entered a passcode from the device, you shouldn't have to do anything on the other device.)
10. When the connection is complete, a list of matching and supported services on the device appears.
11. Select the services you want to use and tap Finish. The services on the new devices have to be selected or else the pairing won't include those services, even though the devices are paired. If services are not selected, you will be continually reprompted for the passcode from the device.
12. The device appears in the list on the main window.

After the passcodes have been accepted on both sides, you have a trusted (“paired”) connection.

Available Services

✓ **NOTE** Some devices might not require a PIN. This depends upon the device's authentication.

See the following sections for information on available services.

Object Push Services via Beam

✓ **NOTE** You can only send files to a remote device using the Beam function.

Use the OBEX Push Service to send files and contacts to another Bluetooth device. To transfer files between the MC75A and another Bluetooth enabled device:

1. Ensure that Bluetooth is enabled and discoverable on both devices.
2. Ensure that the two devices are within 30 feet (10 meters) of one another.
3. Tap **Start > Programs > File Explorer**.
4. Navigate to the file to transfer.
5. Tap and hold on the filename until the pop-up menu appears.

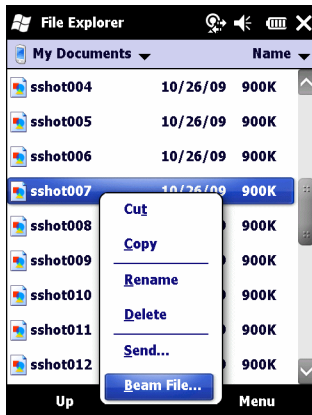

Figure 6-7 File Explorer Window

6. Select **Beam File**. The MC75A searches for Bluetooth devices in the area.
7. Tap **Tap to send** next to the Bluetooth device to send the file to. The MC75A communicates with the device and send the file. When completed, **Tap to send** changes to **Done**.

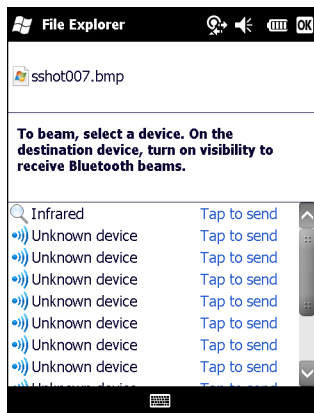

Figure 6-8 Beam File Window

To transfer a contact between the MC75A and another Bluetooth enabled device:

1. Ensure that Bluetooth is enabled and discoverable on both devices.
2. Ensure that the two devices are within 30 feet (10 meters) of one another.
3. Tap **Start > Contacts**
4. Navigate to the contact to transfer.
5. Tap and hold on the contact until the pop-up menu appears.



Figure 6-9 Contact Window

6. Select **Send Contact > Beam**. The MC75A searches for Bluetooth devices in the area.
7. Tap **Tap to send** next to the Bluetooth device to send the file to. The MC75A communicates with the device and send the contact. When completed, **Tap to send** changes to **Done**.

Internet Sharing

Internet Sharing allows the user to connect a computer or laptop to the MC75A and use the MC75A as a modem to connect to an office network or ISP.

To use MC75A as a modem using Bluetooth:

1. Ensure that the device is not connected to the computer or laptop.
2. On the MC75A, ensure that the Phone is on and a data connection is configured.

3. Tap > **Programs** > **Internet Sharing**.
4. In the **PC Connection** list, select **Bluetooth PAN**.
5. In the **Network Connection** list, select the connection type.
Select the network connection that the device should use to connect to the Internet.
6. Tap **Connect**.
7. On the computer or laptop, setup a Bluetooth PAN with your device.
 - a. Select **Start** > **Control Panel** > **Network Connections**.
 - b. Under **Personal Area Network**, select **Bluetooth Network Connection**.
 - c. Right-click on **Bluetooth Network Connection** and select **View Bluetooth** network devices.
 - d. In the **Bluetooth Personal Area Network Devices** window select your device.
 - e. Click **Connect**. The computer connects to the device via Bluetooth.

✓ **NOTE** If your computer is Bluetooth-enabled and you select Bluetooth as the PC connection, you must initiate and complete the Bluetooth PAN partnership before Internet Sharing will work. For more information, refer to Windows Help and Support.

8. To verify, on the PC or laptop, launch **Internet Explorer** and open a web site.
9. To end dial-up networking, on the MC75A tap **Disconnect**.

Hands-free Services

To connect to a Bluetooth headset:

✓ **NOTE** Newer Bluetooth headsets are device dependant and remember the last device they connected to. If problems occur while connecting to the headset, place the headset in discovery mode. Refer to the headset user manual for more information.

Only WAN audio is routed to the headset. System audio is still emitted through the MC75A speaker.

You can accept calls and re-dial using the Hands-free profile.

1. Ensure that Bluetooth is enabled and discoverable on both devices.
2. Ensure that the two devices are within 30 feet (10 meters) of one another.
3. Tap **Start** > **Settings** > **Connections** > **Bluetooth** icon.
4. Tap **New device**. The MC75A searches for Bluetooth devices in the area.
5. Select the headset name and tap **Next**. The Passcode window appears.
6. Enter the headset's passcode.
7. Tap **Next**. The MC75A connects to the headset. Refer to the headset user manual for instructions on communicating with a Bluetooth device.

✓ **NOTE** During an active connection, the MC75A cannot go into suspend mode when the Power Button is pressed. A message appears notifying the user.

Once the WAN call is disconnected (with Hands-free profile) the Power button is enabled.

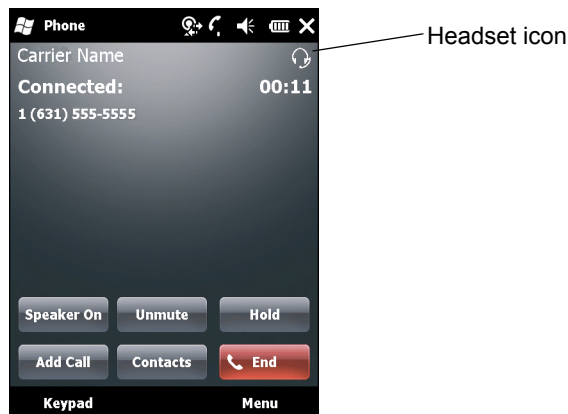

Figure 6-10 WWAN Bluetooth Audio Notification Dialog Box

Serial Port Services

Use the wireless Bluetooth serial port connection as you would a physical serial cable connection. Configure the application that will use the connection to the correct serial port.

To establish a serial port connection:

1. Ensure that Bluetooth is enabled and discoverable on both devices.
2. Ensure that the two devices are within 30 feet (10 meters) of one another.
3. Tap **Start > Settings > Connections tab > Bluetooth icon > Devices tab**.
4. Tap **Add new device**. The MC75A begins searching for discoverable Bluetooth devices in the area.
5. Select a device from the list.
6. Tap **Next**. The **Enter Passcode** window appears.

✓ **NOTE** If Smart-pairing is configured and the device is requesting one of the pre-defined PINs, the **Enter Passcode** window does not appear.

7. Enter the Passcode and the tap **Next**. The device is added to the Bluetooth list.
8. In the device list, tap the serial device. The **Partnership Settings** window displays.
9. Select the **Serial Port** checkbox.
10. Tap **Save**.
11. Tap **COM Ports** tab.
12. Tap **New Outgoing Port**. The add device window appears.
13. Select the serial device in the list and then tap **Next**.
14. Select a COM port from the drop-down list.
15. Tap **Finish**.

✓ **NOTE** No connection is made at this point. An application must open the selected COM port to trigger Microsoft Bluetooth stack to open the connection.

ActiveSync Using Serial Port Services

Use the wireless Bluetooth serial port connection for ActiveSync just as you would a physical serial cable connection. You must configure the application that will use the connection to the correct serial port.

To set up a Bluetooth ActiveSync connection:

Before setting up a Bluetooth ActiveSync connection, configure the Bluetooth function of your device.

- ✓ **NOTE** For additional security, disable network bridging on the computer (specifically, bridging to a Remote NDIS adapter) before connecting to the computer to pass through to the Internet or a network. For more information on network bridging, see **Windows Help** on your computer.

The instructions below are for computers that support the Windows XP SP2 or later version operating system.

1. Ensure that Bluetooth is enabled and discoverable on both devices.
2. Ensure that the two devices are within 30 feet (10 meters) of one another.
3. On the computer, click **Start > Settings > Control Panel**.
4. Double-click **Bluetooth Devices**.
5. On the **Options** tab, select the **Turn discovery on** and **Allow Bluetooth devices to connect to this computer** checkboxes.

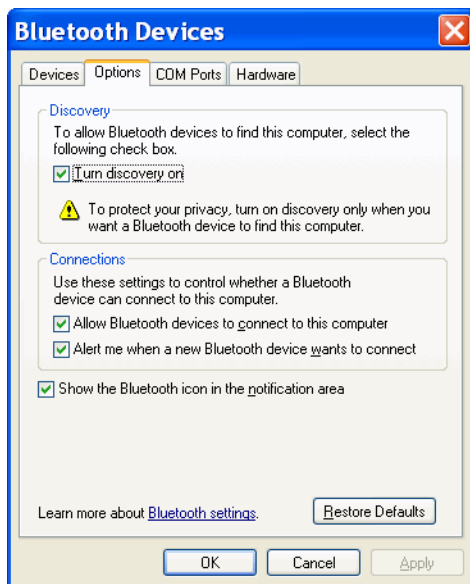

Figure 6-11 Computer Bluetooth Devices Window

6. On the **COM Ports** tab, click **Add**.
7. Select the **Incoming (device initiates the connection)** option, then click **OK**.
Note the number of the COM port that was added.
8. Click **OK**.
9. Click **Start > All Programs > Microsoft ActiveSync**.
10. Click **File > Connection Settings**.



Figure 6-12 ActiveSync Connection Settings

11. On the **Allow connections to one of the following** drop-down list, select the COM port with the number you noted earlier.
12. On the MC75A, tap **Start > Programs > ActiveSync**.
13. Tap **Menu > Connect via Bluetooth**.

Synchronization is automatically initiated. The **ActiveSync** icon appears on the lower right corner of the **Today** screen.

If an Authentication is required, the **Enter Passcode** screen appears, type an alphanumeric passkey (PIN code), then tap **Next**; enter the same passkey on the other device.

The passkey is recommended for enhanced security. Your passkey must be between 1 to 16 alphanumeric characters.

If you do not want to use a passkey, tap **Next**.

14. To disconnect the ActiveSync connection, tap the **ActiveSync** icon on the Today screen.
15. Tap **Disconnect**.

Phone Book Access Profile Services

Phone Book Access profile (PBAP) is used to synchronize contacts between a remote device and the MC75A. To establish an PBAP synchronization:

1. Ensure that Bluetooth is enabled and discoverable on both devices.
2. Ensure that the two devices are within 30 feet (10 meters) of one another.
3. Tap **Start > Settings > Connection tab > Bluetooth icon > Devices tab**.
4. Tap **Add New Device**. The MC75A searches for a Bluetooth device, such as a Car Kit.
5. Select a device from the list.
6. Tap **Next**. The **Enter Passcode** window appears.

✓ **NOTE** If Smart-pairing is configured and the device is requesting one of the pre-defined PINs, the **Enter Passcode** window does not appear.

7. Enter the Passcode and the tap **Next**. The device is added to the Bluetooth list.

8. A dialog box appears requesting if you want to transfer contacts to the car kit.
9. Select **Yes** or **No**.
10. If **Yes** is selected, contacts from the MC75A are transferred to the car kit.

Dial-Up Networking Services

Dial-up networking allows the user to connect a PC or laptop to the MC75A and use the MC75A as a modem to connect to an office network or ISP.

Before setting up dial-up networking, obtain dial-up information and other necessary settings (username, password and domain name, if required) for the office network or ISP. To create a new Bluetooth connection:

1. Ensure the MC75A is discoverable and connectable.
2. On the PC or laptop, set up Bluetooth according to the manufacturer's instructions.
3. On the PC or laptop Bluetooth software, search for the MC75A and select the Dial-up Networking service.
4. Using dial-up software on the PC or laptop, connect to the MC75A.
5. The MC75A phone function dials the ISP number and connects to the ISP.
6. To verify, on the PC or laptop, launch Internet Explorer and open a web site.

Connect to a HID Device

The MC75A can connect to an Human Interface Device (HID) device such as a Bluetooth keyboard or mouse:

1. Ensure that Bluetooth is enabled on both devices.
2. Ensure that the Bluetooth device to discover is in discoverable and connectable modes.
3. Ensure that the two devices are within 30 feet (10 meters) of one another.
4. Tap **Start** > **Settings** > **Connections** tab > **Bluetooth** icon > **Devices** tab.
5. Tap **Add new device**. The MC75A begins searching for discoverable Bluetooth devices in the area.
6. Select a HID device from the list.
7. Tap **Next**. The **Enter Passcode** window appears. Refer to the device's User Manuals for more information.

✓ **NOTE** If Smart-pairing is configured and the device is requesting one of the pre-defined PINs, the **Enter Passcode** window does not appear.

8. Tap **Connect**. The MC75A connects to the HID device.

A2DP/AVRCP Services

A2DP/AVRCP is used to connect to a high-quality stereo headset:

1. Ensure that Bluetooth is enabled on both devices.
2. Ensure that the Bluetooth device to discover is in discoverable and connectable modes.
3. Ensure that the two devices are within 30 feet (10 meters) of one another.
4. Tap **Start** > **Settings** > **Connections** tab > **Bluetooth** icon > **Devices** tab.

5. Tap **Add new device**. The MC75A begins searching for discoverable Bluetooth devices in the area.
6. Select a stereo headset from the list.
7. Tap **Next**. The **Enter Passcode** window appears. Refer to the device's User Manuals for more information.

✓ **NOTE** If Smart-pairing is configured and the device is requesting one of the pre-defined PINs, the **Enter Passcode** window does not appear.

8. Tap **Connect**. The MC75A connects to the stereo headset.

For stereo headsets that can use hands-free services, connect to the hands-free service after connecting to the A2DP service:

1. Tap **Start > Settings > Connections** tab > **Bluetooth** icon > **Devices** tab.
2. Tap **Add new device**. The MC75A begins searching for discoverable Bluetooth devices in the area.
3. Select a stereo headset from the list.
4. Tap **Next**. The **Enter Passcode** window appears. Refer to the device's User Manuals for more information.

✓ **NOTE** If Smart-pairing is configured and the device is requesting one of the pre-defined PINs, the **Enter Passcode** window does not appear.

5. Tap **Connect**. The MC75A connects to the stereo headset.

Using StoneStreet One Bluetooth Stack

The following sections provide information on using the StoneStreet One Bluetooth stack.

Turning the Bluetooth Radio Mode On and Off

Turn off the Bluetooth radio to save power or if entering an area with radio restrictions (e.g., an airplane). When the radio is off, other Bluetooth devices cannot see or connect to the MC75A. Turn on the Bluetooth radio to exchange information with other Bluetooth devices (within range). Communicate only with Bluetooth radios in close proximity.

✓ **NOTE** To achieve the best battery life turn off radios not in use.

Disabling Bluetooth

To disable Bluetooth, tap the Connection icon on the Status bar and select **Wireless Manager** in the Connectivity dialog box. Tap the blue **Bluetooth** bar to turn off the Bluetooth radio.

Enabling Bluetooth

To enable Bluetooth, tap the Connection icon on the Status bar and select **Wireless Manager** in the Connectivity dialog box. Tap the blue **Bluetooth** bar to turn on the Bluetooth radio.

Modes

The BTE Explorer application has two modes for managing Bluetooth connections: Wizard Mode and Explorer Mode. The Wizard Mode is for novice Bluetooth users and the Explorer Mode is for experienced Bluetooth users. To switch between modes, select **View > Wizard Mode** or **View > Explorer Mode**.

Wizard Mode

Wizard Mode provides a simple process for discovering and connecting to Bluetooth devices.

✓ **NOTE** Switching between Wizard Mode and Explorer Mode closes all active connections.

Wizard Mode shows the devices and services in a simple Favorites view created by following the step-by-step wizard.

Explorer Mode

The **Explorer Mode** window is easy to navigate and provides greater control to users familiar with Bluetooth. The menu bar provides quick access to the options and tools used to connect to devices. To access Explorer Mode, tap **View > Explorer Mode**.



Figure 6-13 Explorer Mode Window

You can also use the “tap and hold” technique to view available options. Scroll bars and view options are similar to those on the Windows desktop. The tree structure lists the following sub-items:

- Local Device - This device
- Remote Device - Other Bluetooth devices
 - Trusted Devices - Bonded (paired) Bluetooth devices
 - Untrusted Devices - Discovered devices that are not bonded
- Favorites - Selected services that are set as *Favorite* for quick access.

✓ **NOTE** Switching between Wizard Mode and Explorer Mode closes all active connections.

Discovering Bluetooth Device(s)

The MC75A can receive information from discovered devices without bonding. However, once bonded, the MC75A and a bonded device exchange information automatically when you turn the Bluetooth radio on. See [Bonding with Discovered Device\(s\) on page 6-32](#) for more information.

To find Bluetooth devices in the area:

1. Ensure that Bluetooth is enabled on both devices.
2. Ensure that the Bluetooth device to discover is in discoverable and connectable modes.
3. Ensure that the require profile is enabled on the MC75A. See [Profiles Tab on page 6-45](#) for more information.
4. Ensure that the two devices are within 30 feet (10 meters) of one another.
5. Tap **Start > BTE Explorer**. The **BTE Explorer** window appears.

✓ **NOTE** If favorite connections have already been created, the **Favorites** screen displays. If no favorite connections have been created, the **New Connection Wizard** screen displays.

6. Tap **Menu > New Connection**. The **New Connection Wizard** appears.

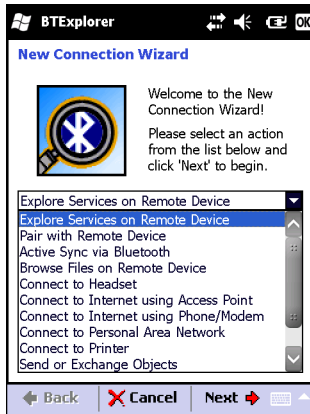

Figure 6-14 BTE Explorer Window

7. Select **Explore Services on Remote Device** or another from the drop-down list and tap **Next**.



NOTE If a device discovery action has not been previously performed, a device discovery is automatically initiated. If a device discovery has previously been performed, the device discovery process is skipped, and the previously found list of devices displays. To start a new device discovery, tap and hold in the window and select **Discover Devices** from the pop-up menu.

8. **BTE Explorer** searches for Bluetooth devices in the area.



Figure 6-15 Discover Devices Dialog Box

The discovered devices display in the **Select Remote Device** window.

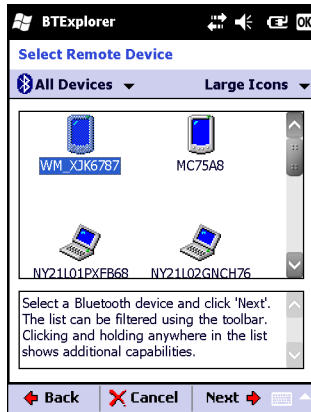

Figure 6-16 Select Remote Device Window

9. Select a device from the list and tap **Next**. The MC75A searches for services on the selected Bluetooth device.

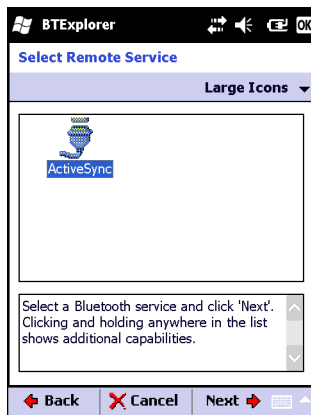

Figure 6-17 Device Services

- ✓ **NOTE** If the MC75A discovers a service but the service is not supported, the service icon is grayed-out.

10. Select a service from the list and press **Next**. The **Connection Favorite Options** window appears.

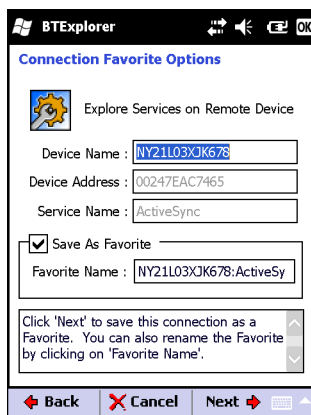

Figure 6-18 Connection Favorite Options Window

11. In the **Favorite Name** text box, enter a name for this service that will appear in the **Favorite** window.

12. Tap **Next**. The **Connection Summary** window appears.
13. Tap **Connect** to add the service to the **Favorite** window and connect to the service.



Figure 6-19 Favorites Window

Available Services

- ✓ **NOTE** Some devices might not require a PIN. This depends upon the device's authentication.

See the following sections for information on available services.

File Transfer Services

- ✓ **NOTE** Shared folders are a security risk.

To transfer files between the MC75A and another Bluetooth enabled device:

1. Ensure that OBEX File Transfer profile is enabled on the MC75A. See [Profiles Tab on page 6-45](#) for more information.

- ✓ **NOTE** If favorite connections have already been created, the **Favorites** screen displays. If no favorite connections have been created, the **New Connection Wizard** screen displays.

2. Use the **Connection Wizard** to search for a Bluetooth device.
3. Select the device and tap **Next**. The **Select Remote Service** window appears.
4. Tap **Next**. The **Connection Favorite Options** window appears.
5. Tap **Next**. The **Connection Summary** window appears.
6. Tap **Connect**. The remote device's accessible folders appear.

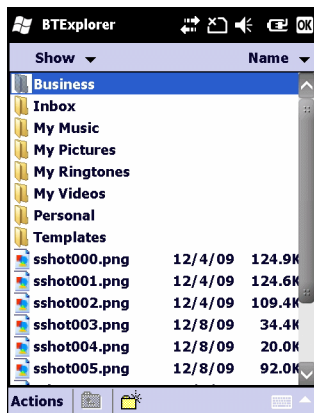

Figure 6-20 File Transfer Window

7. Double-tap the file to copy. The **Save Remote File** window appears.

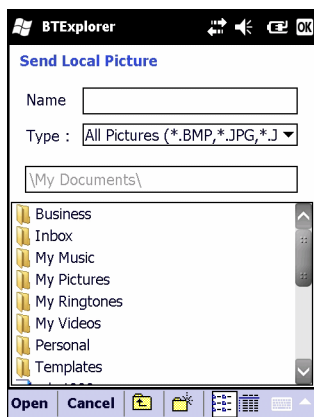

Figure 6-21 Save Remote File Window

8. Tap and hold on the file. A pop-up menu appears.

9. Select the action to perform:

- **New** - create a new file or folder on the remote device
- **Delete** - delete the selected file on the remote device.
- **Get File** - copy the file from the remote device to the MC75A.
- **Put File** - copy a file from the MC75A to the remote device.

Creating a New File or Folder

To create a new folder or file on the remote device:

1. Tap and hold on the screen and select **New > Folder** or **New > File**. The **Create New Folder** or **Create New File** window appears.
2. Enter the name for the new folder or file.
3. Tap **OK** to create the new folder or file on the remote device.

Deleting a File

To delete a file from the remote device:

1. Tap and hold on the file to delete and select **Delete**.
2. In the **Delete Remote Device File** dialog box tap **Yes**.

Getting a File

To copy a file from a remote device:

1. Double-tap or tap and hold on the file and select **Get**. The **Save Remote File** window appears.
2. Navigate to the directory to save the file.
3. Tap **Save**. The file is transferred from the remote device to the MC75A.

Copying a File

To copy a file to a remote device:

1. Tap **Action > Put**. The **Send Local File** window appears.
2. Navigate to the directory to save the file and select a file.
3. Tap **Open**. The file copies from the MC75A to the remote device.

Connecting to the Internet Using an Access Point

This section explains how to access a Bluetooth-enabled LAN access point (AP) for a network connection. Use Internet Explorer to connect to a server.

1. Ensure the MC75A is discoverable and connectable. See [Device Info Tab on page 6-34](#).
2. Ensure that the **Personal Area Networking** profile is enabled on the MC75A. See [Profiles Tab on page 6-45](#) for more information.
3. Use the **Connection Wizard** to search for a Bluetooth AP.

✓ **NOTE** If favorite connections have already been created, the **Favorites** screen displays. If no favorite connections have been created, the **New Connection Wizard** screen displays.

4. Select the **Personal Area Network** or **Network Access** service and select **Connect** from the pop-up menu. The MC75A connects with the access point.
5. Tap **Start > Internet Explorer**. The **Internet Explorer** window appears.
6. In the address field, enter an internet address and tap the **Enter** button. The web page loads.

✓ **NOTE** Network Access profile is not supported.

Dial-Up Networking Services

Dial-up networking allows the user to connect a PC or laptop to the MC75A and use the MC75A as a modem to connect to an office network or ISP.

Before setting up dial-up networking, obtain dial-up information and other necessary settings (username, password and domain name, if required) for the office network or ISP. To create a new Bluetooth connection:

1. Ensure the MC75A is discoverable and connectable. See [Device Info Tab on page 6-34](#).
2. Ensure that the **Dial-Up Networking** profile is enabled on the MC75A. See [Profiles Tab on page 6-45](#) for more information.
3. Tap **Menu > Settings > Services** tab.
4. Tap **Add** button.
5. Select **Dial-up networking Service**.
6. Tap **OK**. The **Edit Local Services** window appears.

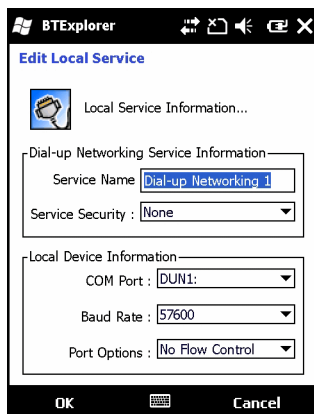

Figure 6-22 *Edit Local Service Window*

7. In the **Local COM Port** drop-down list, select **DUN1** for GSM configurations or **WMP9** for CDMA configurations.
8. Tap **OK** twice.
9. On the PC or laptop, set up Bluetooth according to the manufacturer's instructions.
10. On the PC or laptop Bluetooth software, search for the MC75A and select the Dial-up Networking service.
11. Using dial-up software on the PC or laptop, connect to the MC75A.
12. The MC75A phone function dials the ISP number and connects to the ISP.
13. To verify, on the PC or laptop, launch Internet Explorer and open a web site.

Object Exchange Push Services

Object Exchange (OBEX) is a set of protocols that allows sharing objects such as Contacts or pictures using Bluetooth.

To exchange contact information with another Bluetooth enabled device:

1. Ensure the MC75A is discoverable and connectable. See [Device Info Tab on page 6-34](#).
2. Ensure that the **OBEX Object Push** profile is enabled on the MC75A. See [Profiles Tab on page 6-45](#) for more information.

✓ **NOTE** If favorite connections have already been created, the **Favorites** screen displays. If no favorite connections have been created, the **New Connection Wizard** screen displays.

3. Use the **Connection Wizard** to search for a Bluetooth device.

4. Select the device and tap **Next**.
5. Select the **OBEX Object Push** service and select **Connect**. The **OBEX Object Push** window appears.
6. In the **Action** drop-down list, select one of the following options: **Send Contact Information**, **Swap Contact Information**, **Fetch Contact Information**, or **Send a Picture**.

Sending a Contact

To send a contact to another device:

- ✓ **NOTE** Prior to sending and receiving contacts, a default contact must be set up before attempting to send a contact.

1. Tap and hold on **OBEX Object Push** and select **Connect**. The **OBEX Object Push** window appears.



Figure 6-23 *OBEX Object Push Window*

2. In the **Action:** drop-down list, select **Send Contact Information**.
3. Tap . The **Select Contact Entry** window appears.

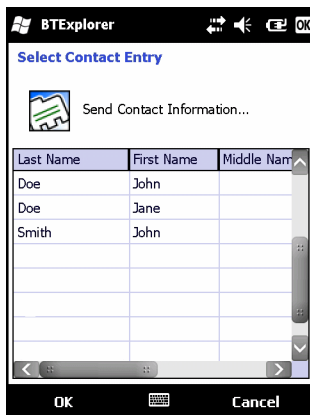

Figure 6-24 *Select Contact Entry Window*

4. Select a contact to send to the other device.
5. Tap **OK**.
6. Tap **OK** to send the contact to the other device and display a confirmation dialog box on the other device to accept the contact. A **Send Contact** dialog appears.

7. Tap **Ok**.

Swapping Contacts

To swap contacts with another device:

- ✓ **NOTE** Prior to swapping contacts, a default contact must be set up before attempting to send a contact.
Ensure that the MC75A is connectable.

1. Tap and hold on **OBEX Object Push** and select **Connect**. The **OBEX Object Push** window appears.

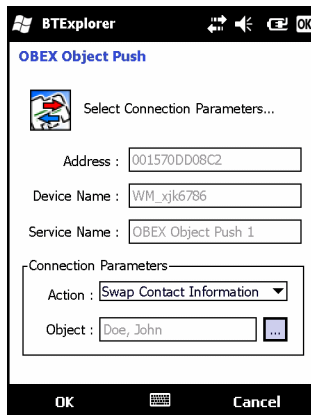

Figure 6-25 OBEX Object Push Window

2. In the **Action:** drop-down list, select **Swap Contact Information**.
3. Tap **...**. The **Select Contact Entry** window appears.

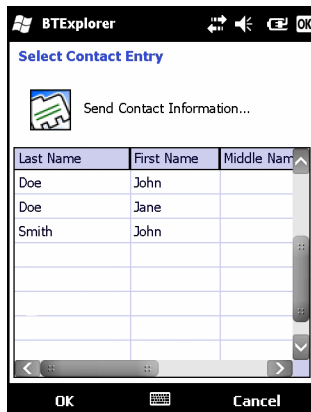

Figure 6-26 Select Contact Entry Window

4. Select a contact to send to the other device.
5. Tap **OK**.
6. Tap **OK** to swap contacts with the other device and display a confirmation dialog box on the other device to accept the contact.
7. Tap **Ok**.

Fetching a Contact

To fetch a contact from another device:

- ✓ **NOTE** Prior to sending and receiving contacts, a default contact must be set up before attempting to send a contact. Ensure that the MC75A is connectable.

1. Tap and hold on **OBEX Object Push** and select **Connect**. The **OBEX Object Push** window appears.

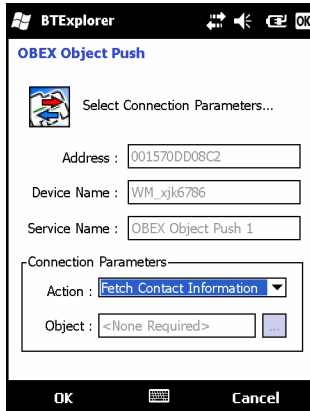

Figure 6-27 OBEX Object Push Window

2. In the **Action:** drop-down list, select **Fetch Contact information**.
3. Tap **OK**. The contact on the other device is copied.

Sending a Picture

To send a picture to another device:

1. Tap and hold on **OBEX Object Push** and select **Connect**. The **OBEX Object Push** window appears.



Figure 6-28 OBEX Object Push Window

2. In the **Action:** drop-down list, select **Send A Picture**.
3. Tap . The **Send Local Picture** window appears.

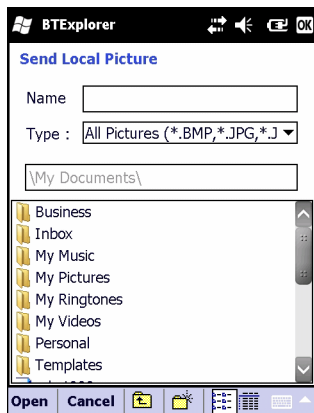

Figure 6-29 Send Local Picture Window

4. Navigate to the picture to send to the other device.
5. Tap **Open**.
6. Tap **OK** to send the picture to the other device and display a confirmation dialog box on the other device to accept the picture. A **Send Picture** dialog appears.
7. Tap **Ok**.

Headset Services

To connect to a Bluetooth headset:

1. Ensure the MC75A is connectable (required when automatic re-connect is initiated). See [Device Info Tab on page 6-34](#).
2. Ensure that the **Headset** Audio Gateway service is enabled on the MC75A (required when automatic re-connect is initiated). See [Services Tab on page 6-34](#) for more information.
3. Use the **Connection Wizard** to search for a Bluetooth headset.
4. Select the device and tap **Next**.
5. Select the **Headset** service name and select **Connect**. A beep is heard in the headset. Refer to the headset user manual for instructions on communicating with a Bluetooth device.

✓ **NOTE** When using a Bluetooth headset with Headset Services, you cannot accept or end a call from the headset. You must accept or end a call on the MC75A.

6. Press the call button on the headset to accept the connection. System audio is heard on the Bluetooth headset.
7. When a call is received on the MC75A, tap the **Accept** button on the MC75A to answer the call. If the call button is pressed, the Bluetooth connection is disconnected.

✓ **NOTE** Newer Bluetooth headsets are device dependant and remember the last device they connected to. If problems occur while connecting to the headset, place the headset in discovery mode. Refer to the headset user manual for more information.

Hands-free Services

To connect to a Bluetooth headset:

✓ **NOTE** Newer Bluetooth headsets are device dependent and remember the last device they connected to. If problems occur while connecting to the headset, place the headset in discovery mode. Refer to the headset user manual for more information.

Only WAN audio is routed to the headset. System audio is still emitted through the MC75A speaker.

You can accept calls and re-dial using the Hands-free profile.

Hands-free profile does not support 3-way calling.

1. Ensure the MC75A is connectable (required when automatic re-connect is initiated). See [Device Info Tab on page 6-34](#).
2. Ensure that the **Hands Free** profile is enabled on the MC75A. See [Profiles Tab on page 6-45](#) for more information.
3. Use the **Connection Wizard** to search for a Bluetooth hands-free headset.
4. Select the hand-free device and tap **Next**.
5. Select the **Hands-free** service name and select **Connect**. The MC75A connects to the headset. Refer to the headset user manual for instructions on communicating with a Bluetooth device.
6. During an active connection, the MC75A cannot go into suspend mode when the Power Button is pressed. A message appears notifying the user.

Once the WAN call is disconnected (with Hands-free profile) the Power button is enabled.

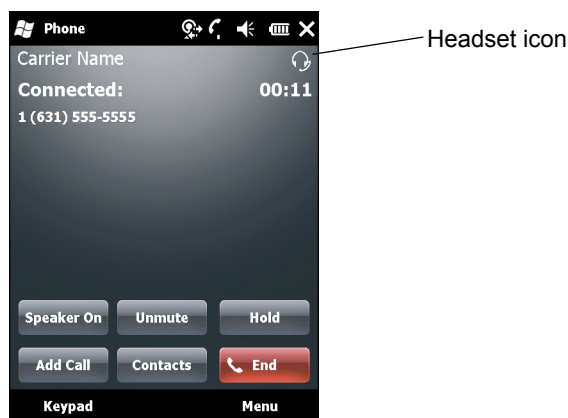

Figure 6-30 WWAN Bluetooth Audio Notification Dialog Box

Serial Port Services

Use the wireless Bluetooth serial port connection as you would a physical serial cable connection. Configure the application that will use the connection to the correct serial port.

To establish a serial port connection:

1. Use the **Connection Wizard** to search for a Bluetooth serial device.
2. Select the device and tap **Next**. The **Connection Favorite Options** window appears.

3. In the **Local COM Port:** drop-down list select a COM port.
4. Tap **Finish**.

ActiveSync Using Serial Port Services

- ✓ **NOTE** By default, COM ports COM5, COM9, COM11, COM21, COM22 and COM23 are Bluetooth virtual ports. If an application opens one of these ports, the Bluetooth driver activates and guides you through a Bluetooth connection.

Use the wireless Bluetooth serial port connection for ActiveSync just as you would a physical serial cable connection. You must configure the application that will use the connection to the correct serial port.



Figure 6-31 ActiveSync Connection Settings Window on PC

To establish an ActiveSync connection:

1. Ensure that the **Sync** profile is enabled on the MC75A. See [Profiles Tab on page 6-45](#) for more information.
2. Use the **Connection Wizard** to search for a Bluetooth device, such as a PC. In the drop-down list select **ActiveSync via Bluetooth**.
3. Select the device and tap **Next**. The **Connection Favorite Options** window appears.
4. Tap **Connect**. The **Remote Service Connection** window appears.

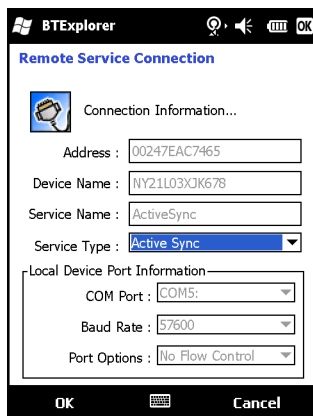

Figure 6-32 Remote Service Connection Window

5. In the **Service Type** drop-down list, select **Active Sync**.

6. Tap **OK**. The MC75A connects the PC and an ActiveSync session begins.
7. Tap **Finish**. The Connection Favorite Options window appears.
8. To end the session, tap the ActiveSync icon in the **Favorite** window and select **Disconnect** from the pop-up window.

Personal Area Network Services

✓ **NOTE** This profile supports Ad-hoc and PAN User. Network Access Profile is not supported.

Connect two or more Bluetooth devices to share files, collaborate, or play multi-player games. To establish a Personal Area Network connection:

1. Ensure that the **Personal Area Networking** profile is enabled on the MC75A. See [Profiles Tab on page 6-45](#) for more information.
2. Use the **Connection Wizard** to search for a Bluetooth device.
3. Select the device and tap **Next**. The **Connection Favorite Options** window appears.
4. Tap **Next**. The **Connection Summary** window appears.
5. Tap **Connect**. The MC75A connects to the Bluetooth device.

IrMC Synchronization Services

IrMC Synchronization is used to synchronize PIM contacts between a remote device and the MC75A. To establish an IrMC synchronization:

1. Ensure the MC75A is connectable (required when automatic re-connect is initiated). See [Device Info Tab on page 6-34](#).
2. Ensure that the **Sync** profile is enabled on the MC75A. See [Profiles Tab on page 6-45](#) for more information.
3. Tap **Menu > Settings > Services** tab.
4. Tap **Add** button.
5. Select **IrMC Synchronization**.
6. Tap **OK**. The **Edit Local Services** window appears.
7. Tap **OK** twice.
8. Use the **Connection Wizard** to search for a Bluetooth device, such as a Car Kit.
9. Select the device and tap **Next**. The **Connection Favorite Options** window appears.
10. Tap and hold **IrMA Synchronization** and select **Connect** in the pop-up menu.

✓ **NOTE** To automatically transfer contact with a Car Kit, ensure that the IrMC Synchronization service is enabled on the MC75A.

A2DP/AVRCP Services

A2DP/AVRCP is used to connect to a high-quality stereo headset:

1. Ensure the MC75A is connectable (required when automatic re-connect is initiated). See [Device Info Tab on page 6-34](#).
2. Ensure that the remote Bluetooth device is in discoverable mode. See the devices user manual for instructions.
3. Ensure that the **A2DP/AVRCP** profile is enabled on the MC75A. See [Profiles Tab on page 6-45](#) for more information.
4. Tap **Menu > Settings > Services** tab.
5. Tap **Add** button.
6. Select **Advanced Audio Distribution Services**.
7. Tap **OK**. The **Edit Local Services** window appears.
8. Tap **OK** twice.
9. Tap **Menu > New Connection**.
10. Select **Connect to High-Quality Audio** from the drop-down list.
11. Tap **Next**.
12. Select the device and tap **Next**.
13. Enter the PIN Code for the remote device and then tap **OK**. The **Connection Favorite Options** window appears.
14. Tap **Next**.
15. Tap **Connect**. The MC75A connects to the high-quality audio headset.

For stereo headsets that can use hands-free services, connect to the hands-free service after connecting to the A2DP service:

1. Tap **Menu > New Connection**.
2. Select **Connect to Headset** from the drop-down list.
3. Tap **Next**.
4. Select the stereo headset and tap **Next**.
5. Select the **Hands-Free unit** service and then tap **Next**.
6. Tap **Next**.
7. Tap **Connect**.

Connect to a HID Device

The MC75A can connect to an Human Interface Device (HID) device such as a Bluetooth keyboard:

1. Ensure the MC75A is connectable (required when automatic re-connect is initiated). See [Device Info Tab on page 6-34](#).
2. Ensure that the remote Bluetooth device is in discoverable mode. See the device user manual for instructions.
3. Ensure that the **HID Client** profile is enabled on the MC75A. See [Profiles Tab on page 6-45](#) for more information.

4. Tap **Menu > New Connection**.
5. Select **Explore Services on Remote Device** from the drop-down list.
6. Tap **Next**.
7. Select the device and tap **Next**.
8. Select the service and tap **Next**.
9. The **Connection Favorite Options** window appears.
10. Tap **Next**.
11. Tap **Connect**. The MC75A connects to the HID device.

Bonding with Discovered Device(s)

A bond is a relationship created between the MC75A and another Bluetooth device in order to exchange information in a secure manner. Creating a bond involves entering the same PIN on the two devices. After creating a bond and turning on the Bluetooth radios, the devices recognize the bond and can exchange information without re-entering a PIN.

To bond with a discovered Bluetooth device:

- ✓ **NOTE** If favorite connections have already been created, the **Favorites** screen displays. If no favorite connections have been created, the **New Connection Wizard** screen displays.

1. Tap **Start > BTE Explorer**. The **BTE Explorer** window appears.
2. Tap **Menu > New Connection**. The **New Connection Wizard** window appears.
3. In the drop-down list, select **Pair with Remote Device**.
4. Tap **Next**. The **Select Remote Device** window appears.

- ✓ **NOTE** Devices discovered previously are listed to save time. To start a new device discovery, tap and hold on the list area and select **Discover Devices** from the pop-up menu.



Figure 6-33 Select Remote Device Window

5. Select a device from the list and tap **Next**. The **PIN Code Request** window appears.



Figure 6-34 Connection Favorite Options Window

6. In the **PIN Code** field, enter the PIN code.
7. Tap **OK**. The **Pairing Status** window displays.
8. Tap **Finish**. The devices are successfully paired. The device name moves to the **Trusted Devices** window.

Deleting a Bonded Device

To delete a device no longer needed:

1. Tap **Start > BTExplorer**. The **BTExplorer** window appears.
2. Tap **Menu > Trusted Devices**. The **Trusted Devices** window appears.
3. Tap and hold on the device select **Delete Link Key** in the pop-up menu.
4. A confirmation dialog appears. Tap **Yes**.

Accepting a Bond

When a remote device wants to bond with the MC75A, enter a PIN when requested to grant permission.

1. Ensure that the MC75A is set to discoverable and connectable. See [Bluetooth Settings on page 6-34](#). When prompted to bond with the remote device the **PIN Code Request** window appears.



Figure 6-35 PIN Code Request Window

2. In the **PIN Code:** text box, enter the same PIN entered on the device requesting the bond. The PIN must be between 1 and 16 characters.
3. In the **Device Name:** text box, edit the name of the device requesting the bond, if desired.
4. Tap **OK** to create the bond. The MC75A can now exchange information with the other device.

Bluetooth Settings

Use the **BTE Explorer Settings** window to configure the operation of the **BTE Explorer** application. Tap **Menu > Settings**. The **BTE Explorer Settings** window appears.

Device Info Tab

Use the **Device Info** tab to configure the MC75A's Bluetooth connection modes.



Figure 6-36 BTE Explorer Settings - Device Info Tab

Table 6-3 Device Info Tab Data

Item	Description
Device Name	Displays the name of the MC75A.
Discoverable Mode	Select whether or not the MC75A is discoverable by other Bluetooth devices.
Connectable Mode	Select whether or not the MC75A is connectable by other Bluetooth devices.

Services Tab

- ✓ **NOTE** Ensure that the MC75A is discoverable and connectable when remote devices use MC75A services.

Use the **Services** tab to add or delete Bluetooth services.

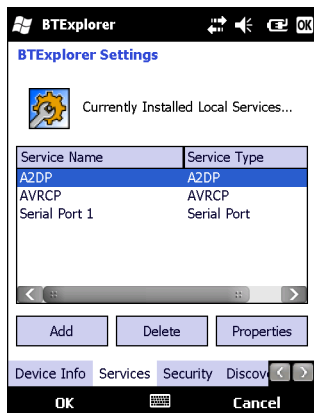

Figure 6-37 BTE Explorer Settings - Services Tab

To add a service:

1. Tap **Add**. The **Add Local Service** window displays.

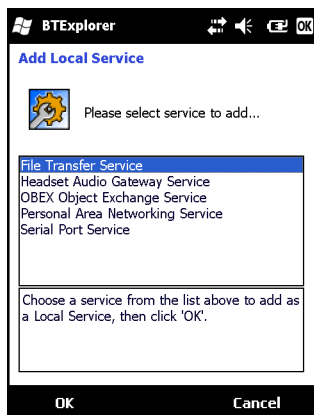

Figure 6-38 Add Local Service Window

2. In the list, select a service to add.
3. Tap **OK**. The **Edit Local Service** window displays for the selected service.
4. Select the appropriate information and then tap **OK**. See the following sections for information on the available services.

Dial-Up Networking Service

Dial-up Networking allows other Bluetooth devices to access a dial-up modem.

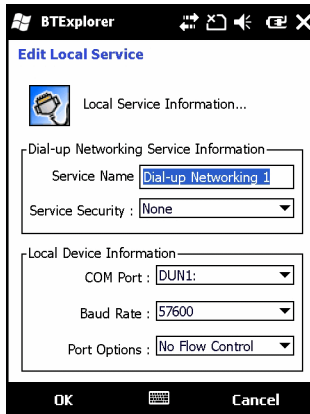

Figure 6-39 BTE Explorer Settings - Dial-up Networking Information

Table 6-4 Dial-up Networking Information Data

Item	Description
Service Name	Displays the name of the service.
Service Security	Select the type of security from the drop-down list. Options are None , Authenticate , or Authenticate/Encrypt .
Local COM Port	Select the COM port.
Local Baud Rate	Select the communication baud rate.
Local Port Options	Select the port option.

File Transfer Service

File transfer allows other Bluetooth devices to browse files.

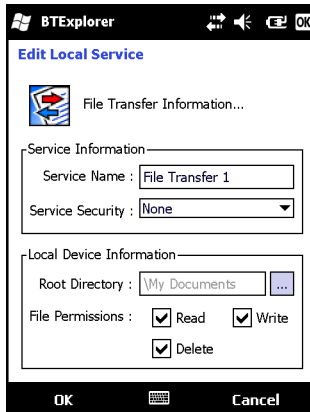

Figure 6-40 BTE Explorer Settings - File Transfer Information

Table 6-5 File Transfer Information Data

Item	Description
Service Name	Displays the name of the service.
Service Security	Select the type of security from the drop-down list. Options are None , Authenticate , or Authenticate/Encrypt .
Root Directory	Select the directory that other Bluetooth devices can access.
File Permissions	Select the file permissions for the selected directory. Check the appropriate box to grant read access, write access, and delete access.

Hands-Free Audio Gateway Service

Hands-Free Service Audio Gateway allows connection to hands-free devices.



Figure 6-41 BTE Explorer Settings - Hands-Free Audio Gateway

Table 6-6 Hands-Free Audio Gateway Data

item	Description
Service Name	Lists the name of the audio service.

Headset Audio Gateway Service

Headset Service Audio Gateway allows connection to headset devices.

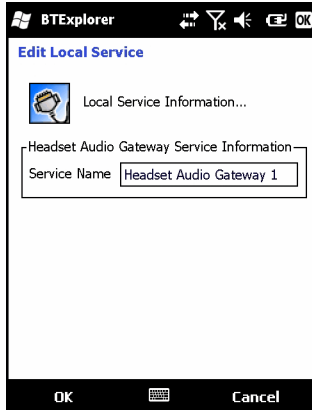

Figure 6-42 BTE Explorer Settings - Headset Audio Gateway

Table 6-7 Headset Audio Gateway Data

Item	Description
Service Name	Lists the name of the audio service.

IrMC Synchronization Service

The IrMC Synchronization service used to synchronize PIM contacts between a remote device and the MC75A.

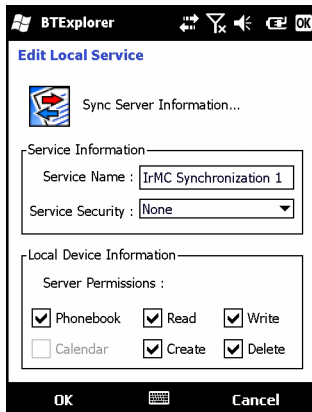

Figure 6-43 BTE Explorer Settings - IrMC Synchronization

Table 6-8 *IrMC Synchronization Data*

Item	Description
Service Name	Displays the name of the service.
Service Security	Select the type of security from the drop-down list. Options are None , Authenticate , or Authenticate/Encrypt .
Phonebook	Select the Phonebook checkbox to allow synchronization with the MC75A's contacts.
	Select Read , Write , Create and/or Delete to allow phonebook permissions.

OBEX Object Push Service

OBEX Object Push allows other Bluetooth devices to push contacts, business cards, pictures, appointments, and tasks to the MC75A.

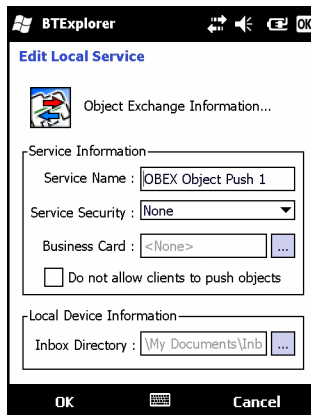
**Figure 6-44** *BTE Explorer Settings - OBEX Exchange Information***Table 6-9** *OBEX Exchange Information Data*

Item	Description
Service Name	Displays the name of the service.
Service Security	Select the type of security from the drop-down list. Options are None , Authenticate , or Authenticate/Encrypt .
Do not allow clients to push objects	Disables clients from pushing objects to the MC75A.
Inbox Directory	Select a directory where another Bluetooth device can store files.

Personal Area Networking Service

Personal Area Networking hosts a Personal Area Network which allows communication with other Bluetooth devices.

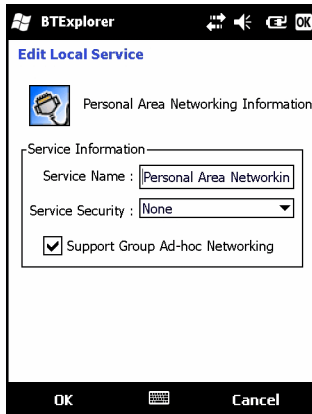

Figure 6-45 BTE Explorer Settings - Personal Area Networking

Table 6-10 Personal Area Networking Data

Item	Description
Service Name	Displays the name of the service.
Service Security	Select the type of security from the drop-down list. Options are None , Authenticate , or Authenticate/Encrypt .
Support Group Ad-Hoc Networking	Select to enable Ad-Hoc networking.

Serial Port Service

Serial port allows other Bluetooth devices to access COM ports.

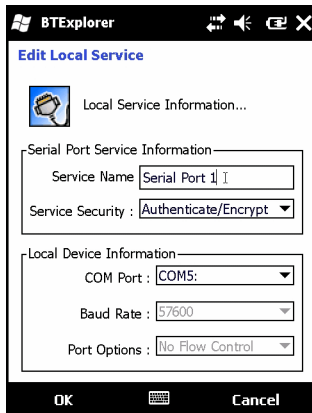

Figure 6-46 BTE Explorer Settings - Serial Port Services

Table 6-11 Serial Port Services Data

Item	Description
Service Name	Displays the name of the service.
Service Security	Select the type of security from the drop-down list. Options are None , Authenticate , or Authenticate/Encrypt .
Local COM Port	Select the COM port.
Local Baud Rate	Select the communication baud rate.
Local Port Options	Select the port option.

Advanced Audio Distribution Service

Advanced Audio Distribution hosts connects from Bluetooth devices supporting high-quality stereo audio.

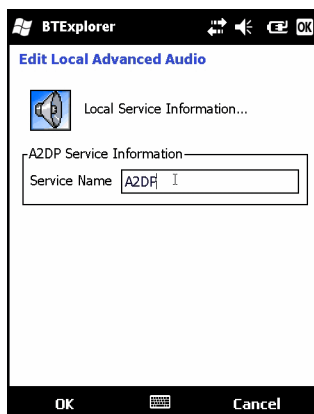
**Figure 6-47** BTE Explorer Settings - Advanced Audio Distribution**Table 6-12** Advanced Audio Distribution Data

Item	Description
Service Name	Lists the name of the audio service.

Audio Video Remote Control Service

Audio Video Remote Control hosts connections from Bluetooth devices supporting audio remote-control functionality.

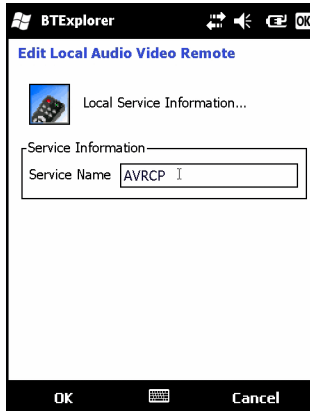

Figure 6-48 BTE Explorer Settings - Audio Video Remote Control

Table 6-13 Audio Video Remote Control Data

Item	Description
Service Name	Lists the name of the audio service.

Security Tab

Security settings allows you to set global security policies for Bluetooth. Note that these settings are only active on local Services that are set to Authenticate or Authenticate/Encryption. You can set authentication on local Services under the Services tab.

To adjust the security settings for an individual service, select the **Services** tab first, then select the individual service, then **Properties**.



Figure 6-49 BTE Explorer Settings - Security Tab



NOTE To use PIN Code, select **Authenticate** or **Authenticate/Encrypt** from the Service Security drop-down list on each local service.

Table 6-14 Security Tab Data

Item	Description
Use PIN Code (Incoming Connection)	Select for automatic use of the PIN code entered in the PIN Code text box. It is recommended not to use this automatic PIN code feature. See Security on page 6-2 for more information.
PIN Code	Enter the PIN code.
Encrypt Link On All Outgoing Connections	Select to enable or disable encryption on all outgoing connections to other Bluetooth devices.

Discovery Tab

Use the **Discovery** tab to set and modify discovered devices.

**Figure 6-50** BTE Explorer Settings - Discovery Tab**Table 6-15** Discovery Tab Data

Item	Description
Inquiry Length	Sets the amount of time the MC75A takes to discover Bluetooth devices in the area.
Name Discovery Mode	Select either Automatic or Manual to automatically attempt to discover a Bluetooth device's name after finding the device.
Discovered Devices - Delete Devices	Deletes all discovered devices and link keys from memory.
Discovered Devices - Delete Linked Keys	Removes all pairing from remote Bluetooth devices, and makes them all un-trusted.

Virtual COM Port Tab

Virtual COM Port defines which COM ports BTE Explorer attempts to use for virtual COM ports. Check the appropriate checkbox to use the port as a virtual COM port. When finished, choose **Apply** to enforce changes, or **Revert** to restore the original settings.

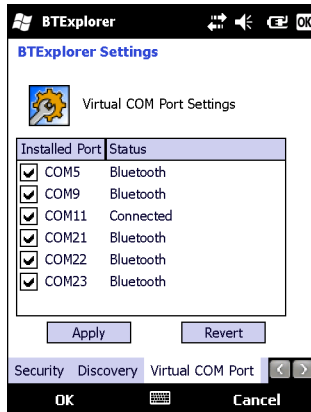

Figure 6-51 BTE Explorer Settings - Virtual COM Port Tab

Table 6-16 Virtual COM Port Tab Data

Item	Description
COM5:Bluetooth	Enable or disable COM Port 5.
COM9:Bluetooth	Enable or disable COM Port 9.
COM11:Bluetooth	Enable or disable COM Port 11.
COM21:Bluetooth	Enable or disable COM Port 21.
COM22:Bluetooth	Enable or disable COM Port 22.
COM23:Bluetooth	Enable or disable COM Port 23.

HID Tab

Use the **HID** tab to select The Human Interface Device Profile programming interface defines the protocols and procedures to be used to implement HID capabilities.

Provides support for devices such as mice, joysticks, keyboards.

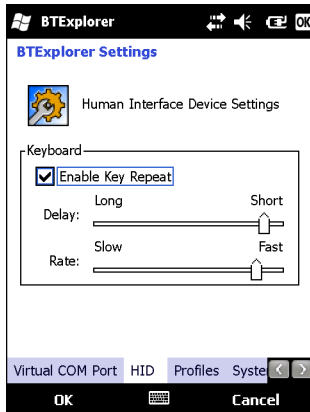

Figure 6-52 BTE Explorer Settings - HID Tab

Table 6-17 HID Tab Data

Item	Description
Enable Key Repeat	Enables key repeat functionality.
Delay	To increase key repeat delay, drag the Delay slider to the right. To decrease key repeat delay, drag the Delay slider to the left.
Rate	To increase key repeat speed, drag the Rate slider to the left. To decrease key repeat speed, drag the Rate slider to the right.

Profiles Tab

Use the **Profile** tab to load or remove Bluetooth services profiles. If a profile is not used, it can be removed to save memory.

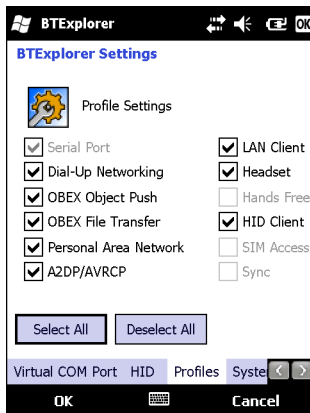

Figure 6-53 BTE Explorer Settings - Profile Tab

1. Tap a check box next to the profile to load (activate).
The Serial Port profile is always active and cannot be removed.
2. Tap **Select All** to select all profiles or tap **Deselect All** to deselect all profiles.
3. Tap **Apply** to activate the profiles and then **Close** to exit the application.

System Parameters Tab

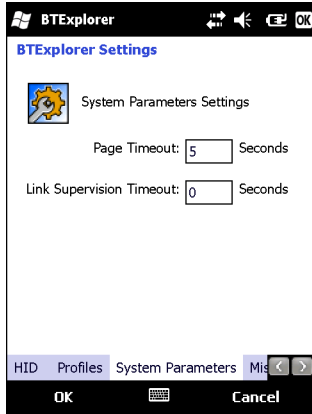

Figure 6-54 BTE Explorer Settings - System Parameters Tab

Table 6-18 System Parameters Tab Data

item	Description
Page Timeout	Sets the amount of time the MC75A searches for a device before moving on to the next device.
Link Supervision Timeout	Sets the amount of time that the MC75A will wait for a device to come back into range after it has gone out of range. If the device does not come back into range by the set time, the MC75A drops the connection.

Miscellaneous Tab

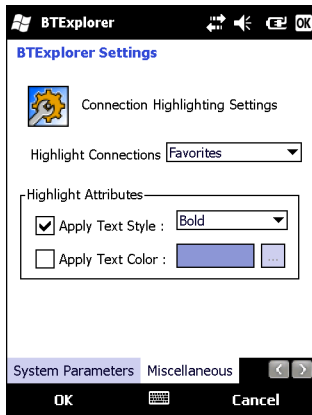

Figure 6-55 BTE Explorer Settings - Miscellaneous Tab

Table 6-19 *Miscellaneous tab Data*

Item	Description
Highlight Connections	Select the connection type to highlight when connected. In the Wizard Mode, the only options are <i>Favorites</i> or <i>None</i> . In the Explorer Mode the options are None , Tree View Only , List View Only , or Tree and List View .
Apply Text Style	Select the text style to apply to the connection text.
Apply Text Color	Select the text color to apply to the connection text.

Chapter 7 Accessories

Introduction

MC75A accessories, listed below, provide a variety of product support capabilities.

Table 7-1 MC75A Accessories

Accessory	Part Number	Description
Cradles		
Single Slot USB/Serial Cradle	CRD7X00-1000RR	Charges the MC75A main battery and a spare battery. Synchronizes the MC75A with a host computer through a USB connection.
Four Slot Ethernet Cradle	CRD7000-4000ER	Charges the MC75A main battery and connects the MC75A with an Ethernet network.
Four Slot Charge Only Cradle	CRD7X00-4000CR	Charges up to four MC75A devices.
VCD7000 Vehicle Cradle	VCD7X00-P000R	Installs in a vehicle and charges the MC75A main battery and a spare battery. Provides serial data communication between an MC75A and an external device.
Chargers		
Four Slot Battery Charger	SAC7X00-4000CR	Charges up to four MC75A spare batteries. Includes an MC75A shim.
Serial Charging Cable	25-102776-01R	Provides power to the MC75A and serial communication with a host computer.
USB Charging Cable	25-102775-01R	Provides power to the MC75A and USB communication with a host computer.
Charge Only Cable	25-95214-02R	Provides power to the MC75A.
Auto Charge Cable	25-70979-01R	Charges the MC75A using a vehicle's cigarette lighter.

Table 7-1 MC75A Accessories (Continued)

Accessory	Part Number	Description
Cables		
DEX Cable	25-76793-01R	Connects the MC75A to a vending machine.
Modem Inverter Cables	25-70924-03R	Modem inverter cable.
O'Neil Printer Cable	25-91519-01R	Printer cable for O'Neil printers.
Zebra Printer Cable	25-91518-01R	Printer cable Zebra Road Warrior printers.
Zebra Printer Cable	25-91515-01R	Printer cable for Zebra QL printers.
Miscellaneous		
Magnetic Stripe Reader (MSR)	MSR7000-100R	Snaps on to the MC75A and adds magstripe read capabilities.
Zebra Snap-On Mobile Payment Module	DCR7X00-100R	Allows easy data capture with the swipe of a magnetic stripe card and personal identification number (PIN) entry using a numeric keypad.
Snap-on Mobile Payment Module with Chip and PIN	DCR7X00-200R	Allows easy data capture with magnetic stripe cards, EMV compliant Chip and PIN cards and personal identification number (PIN) entry using a numeric keypad.
Biometric Reader	MC7XFPR-01R	Contains a finger print reader.
Biometric Reader	MC7XFPSCR-01R	Contains a finger print reader, a contact smart card reader and a contactless smart card reader.
Modem Dongle	MDM9000-100R	Provides modem connectivity.
Spare 3600 mAh lithium-ion battery	BTRY-MC7XEAB00	Replacement 3600 mAh battery.
Spare 4800 mAh lithium-ion battery	BTRY-MC7XEAB0H	Optional 4800 mAh battery.
Battery Kit for 3600 mAh battery	BTRY-KT-1R5X-MC7XR	Replacement 3600 mAh battery and battery door.
Battery Kit for 4800 mAh battery	BTRY-KT-2R5X-MC7XR	Replacement 4800 mAh battery and battery door.
Headset	50-11300-050R	Use in noisy environments.
Belt Mounted Rigid Holster	SG-MC70011110-01R	Clips onto belt to hold the MC75A when not in use.
Fabric Holster	SG-MC7521215-01R	Soft holder for added protection.
Stylus	Stylus-00002-03R	Replacement stylus (3-pack).
Wall Mounting Kit	8710-050006-01R	Use for wall mounting the four slot cradles.
Screen Protector	KT-67525-01R	Package of 3 screen protectors.
Software	-	<i>Enterprise Mobility Developer Kits (Meads)</i> , available at: http://www.zebra.com/support .

Single Slot USB/Serial Cradle

This section describes how to use a Single Slot USB/Serial cradle with the MC75A. For USB communication setup procedures refer to the *MC75A Integrator Guide*.

The Single Slot USB/Serial Cradle:

- Provides 5.4 VDC power for operating the MC75A.
- Synchronizes information between the MC75A and a host computer. Refer to the *MC75A Integrator Guide* for information on setting up a partnership between the MC75A and a host computer.
- Charges the MC75A's battery.
- Charges a spare battery.

Charging the MC75A Battery

Connect the cradle to power. Insert the MC75A into the slot to begin charging.

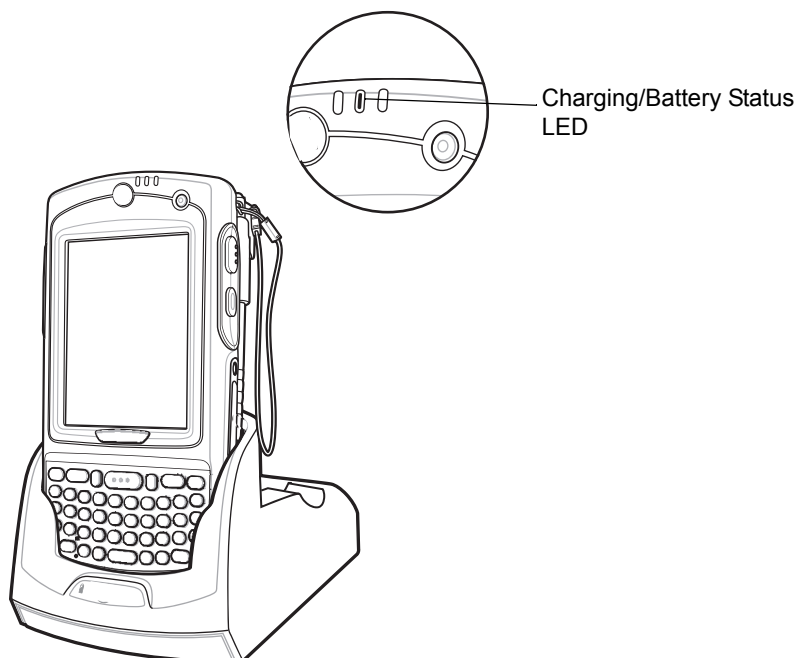

Figure 7-1 MC75A Battery Charging

Charging the Spare Battery

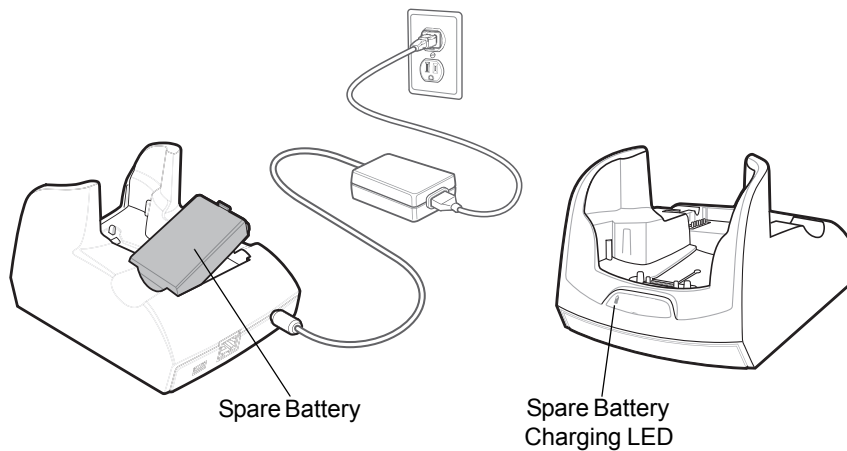

Figure 7-2 Spare Battery Charging

Battery Charging Indicators

The Single Slot USB/Serial Cradle charges the MC75A's main battery and a spare battery simultaneously.

The MC75A's charge LED indicates the status of the battery charging in the MC75A. See [Table 1-2 on page 1-7](#) for charging status indications.

The spare battery charging LED on the cradle indicates the status of the spare battery charging in the cradle. See [Table 7-2](#) for charging status indications.

The 3600 mAh battery fully charges in less than five hours and the 4800 mAh battery fully charges in less than seven hours.

Charging Temperature

Charge batteries in temperatures from 0°C to 40°C (32°F to 104°F). Charging is intelligently controlled by the MC75A.

To accomplish this, for small periods of time, the MC75A or accessory alternately enables and disables battery charging to keep the battery at acceptable temperatures. The MC75A or accessory indicates when charging is disabled due to abnormal temperatures via its LED. See [Table 1-2 on page 1-7](#) and [Table 7-2](#).

Table 7-2 Spare Battery LED Charging Indicators

Spare Battery LED (on cradle)	Indication
Off	Battery is not charging; battery is not inserted correctly in the cradle; cradle is not powered
Slow Blinking Amber	Spare battery is charging.
Solid Amber	Charging complete.
Fast Blinking Amber	Charging error.

Four Slot Ethernet Cradle

This section describes how to set up and use a Four Slot Ethernet cradle with the MC75A. For cradle communication setup procedures refer to the *MC75A Integrator Guide*.

The Four Slot Ethernet cradle:

- Provides 5.4 VDC power for operating the MC75A.
- Connects the MC75A (up to four) to an Ethernet network.
- Simultaneously charges up to four MC75A devices.

Charging

Insert the MC75A into a slot to begin charging.

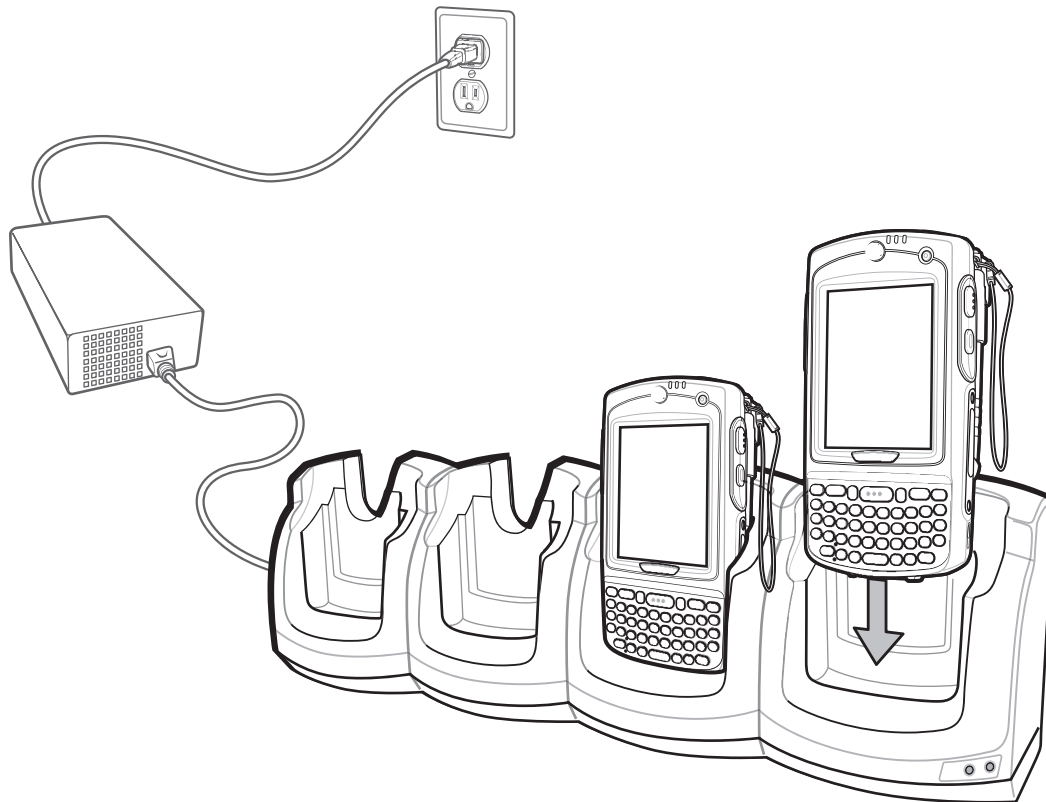

Figure 7-3 MC75A Battery Charging

Battery Charging Indicators

The MC75A's charge LED shows the status of the battery charging in the MC75A. See [Table 1-2 on page 1-7](#) for charging status indications.

The 3600 mAh battery fully charges in less than five hours and the 4800 mAh battery fully charges in less than seven hours.

Charging Temperature

Charge batteries in temperatures from 0°C to 40°C (32°F to 104°F). Charging is intelligently controlled by the MC75A.

To accomplish this, for small periods of time, the MC75A or accessory alternately enables and disables battery charging to keep the battery at acceptable temperatures. The MC75A or accessory indicates when charging is disabled due to abnormal temperatures via its LED. See [Table 1-2 on page 1-7](#).

Four Slot Charge Only Cradle

This section describes how to set up and use a Four Slot Charge Only cradle with the MC75A.

The Four Slot Charge Only cradle:

- Provides 5.4 VDC power for operating the MC75A.
- Simultaneously charges up to four MC75A devices.

Charging

Insert the MC75A into a slot to begin charging.

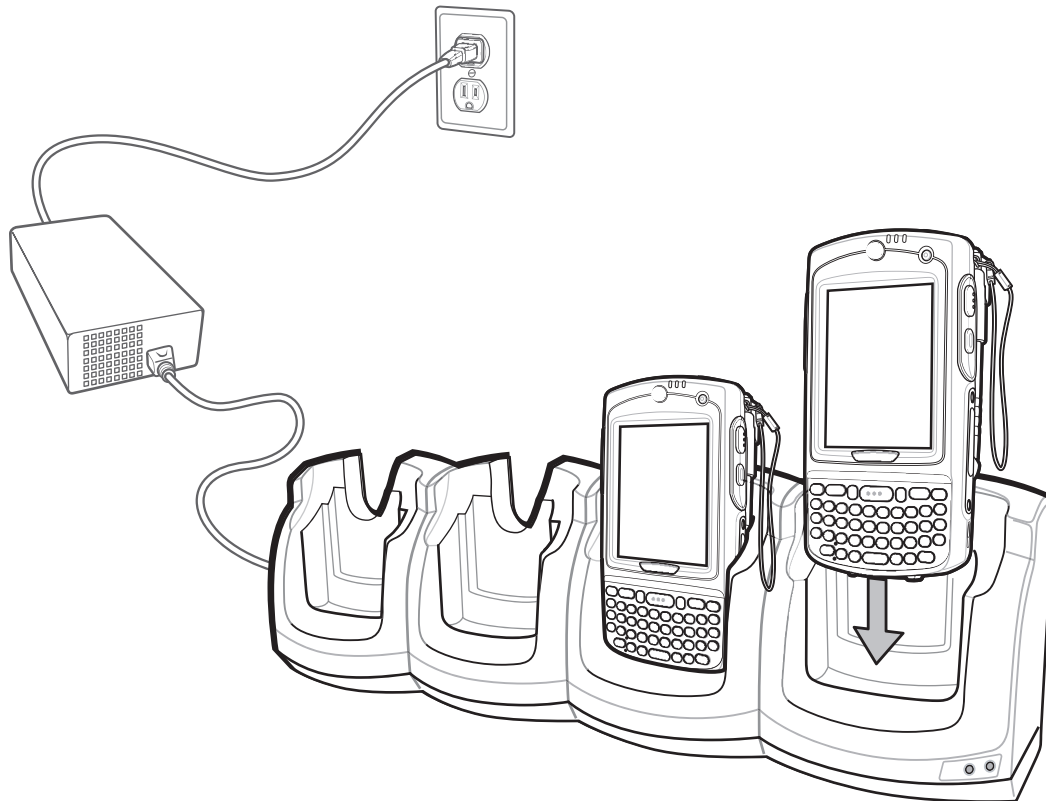

Figure 7-4 MC75A Battery Charging

Battery Charging Indicators

The MC75A's charge LED shows the status of the battery charging in the MC75A. See [Table 1-2 on page 1-7](#) for charging status indications.

The 3600 mAh battery fully charges in less than five hours and the 4800 mAh battery fully charges in less than seven hours.

Charging Temperature

Charge batteries in temperatures from 0°C to 40°C (32°F to 104°F). Charging is intelligently controlled by the MC75A.

To accomplish this, for small periods of time, the MC75A or accessory alternately enables and disables battery charging to keep the battery at acceptable temperatures. The MC75A or accessory indicates when charging is disabled due to abnormal temperatures via its LED. See [Table 1-2 on page 1-7](#).

VCD7X00 Vehicle Cradle

This section describes how to use a VCD7X00 vehicle cradle with the MC75A. For cradle installation and communication setup procedures refer to the *MC75A Integrator Guide*.

Once installed in a vehicle, the cradle:

- holds the MC75A securely in place
- provides power for operating the MC75A
- provides a serial port for data communication between an MC75A and an external device (e.g., a printer)
- re-charges the battery in the MC75A
- re-charges a 3600 mAh or 4800 mAh spare battery.

Charging the MC75A Battery

Insert the MC75A into the vehicle cradle to begin charging. A click indicates that the MC75A button release locking mechanism is enabled and the MC75A is locked in place.

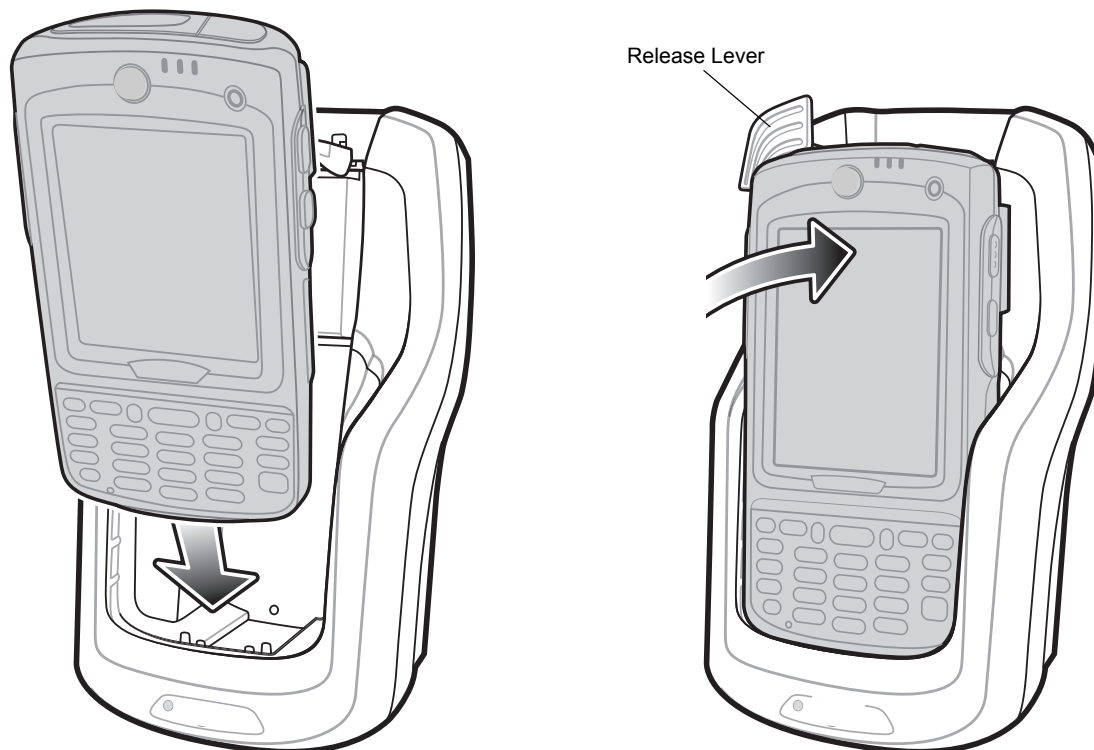

Figure 7-5 MC75A Battery Charging



CAUTION Ensure the MC75A is fully inserted in the cradle. Lack of proper insertion may result in property damage or personal injury. Zebra is not responsible for any loss resulting from the use of the products while driving.

Removing the MC75A

To remove the MC75A, hold back the release lever on the cradle and pull the MC75A up and out of the cradle.

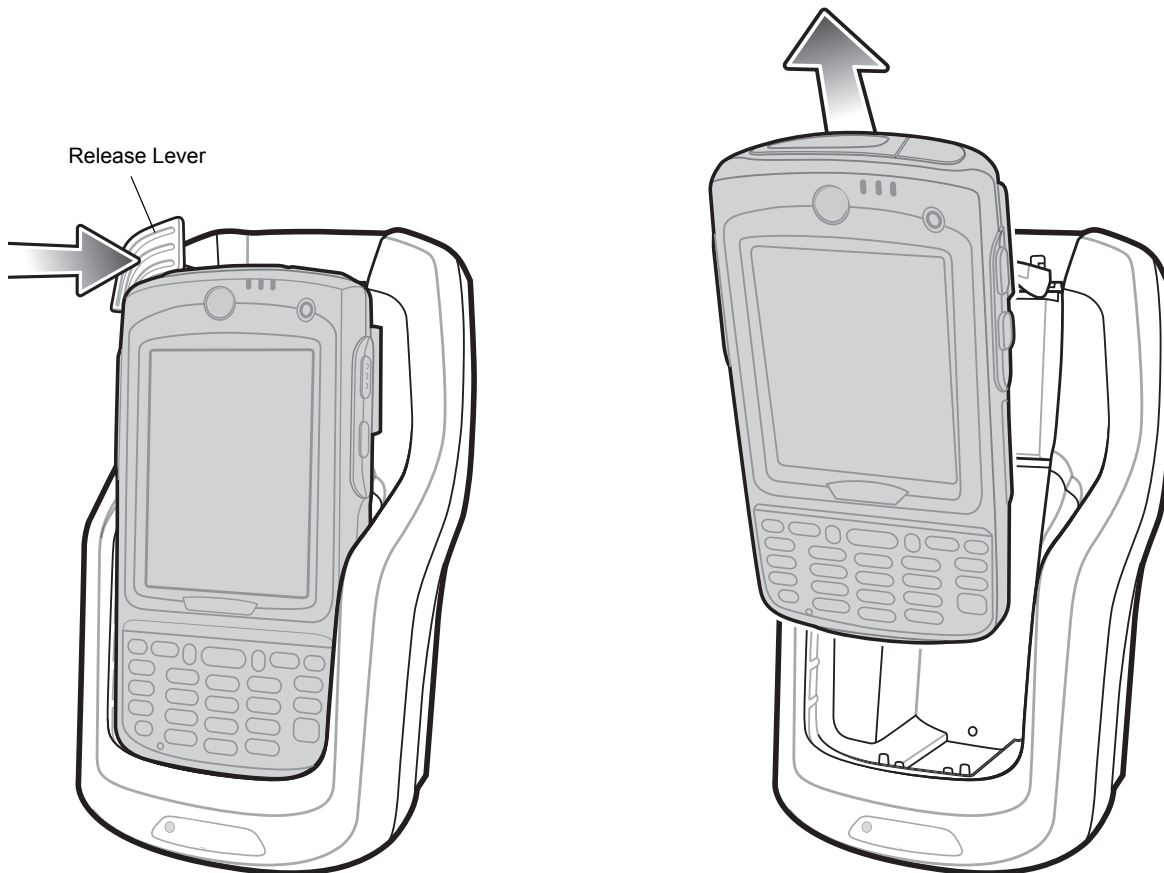

Figure 7-6 Removing the MC75A

Charging the Spare Battery

Insert a spare battery to begin charging:

1. Lift the battery release lever.

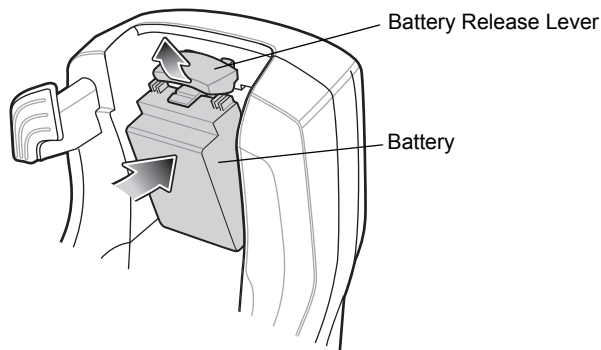

Figure 7-7 Inserting the Spare Battery

2. Insert the spare battery in the spare battery charging slot in the cradle with the charging contacts facing up and to the rear of the cradle.

3. Release the battery release lever. The battery release lever locks the spare battery into place.

To remove a spare battery, hold back the battery release lever and lift the battery from the spare battery slot.

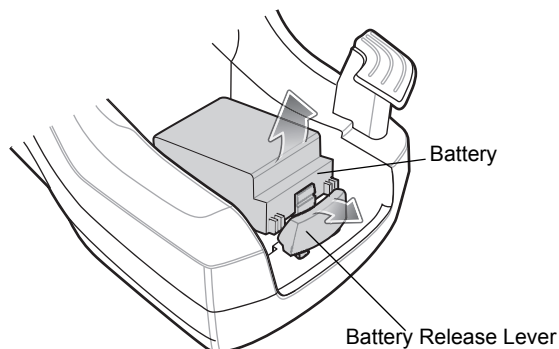

Figure 7-8 Removing the Spare Battery

Battery Charging Indicators

The Vehicle Cradle charges the MC75A's main battery and a spare battery simultaneously.

The MC75A's charge LED indicates the status of the battery charging in the MC75A. See [Table 1-2 on page 1-7](#) for charging status indications.

The spare battery charging LED on the cradle indicates the status of the spare battery charging in the cradle. See [Table 7-3](#) for charging status indications.

The 3600 mAh battery fully charges in less than five hours and the 4800 mAh battery fully charges in less than seven hours.

Charging Temperature

Charge batteries in temperatures from 0°C to 40°C (32°F to 104°F). Charging is intelligently controlled by the MC75A.

To accomplish this, for small periods of time, the MC75A or accessory alternately enables and disables battery charging to keep the battery at acceptable temperatures. The MC75A or accessory indicates when charging is disabled due to abnormal temperatures via its LED. See [Table 1-2 on page 1-7](#) and [Table 7-3](#).

Table 7-3 Vehicle Cradle Spare Battery LED Charging Indicators

Spare Battery LED (on cradle)	Indication
Off	Battery is not charging; battery is not inserted correctly in the cradle; cradle is not powered
Slow Blinking Amber	Spare battery is charging.
Solid Amber	Charging complete.
Fast Blinking Amber	Charging error.

Four Slot Battery Charger

This section describes how to use the Four Slot Battery Charger to charge up to four MC75A batteries.

MC75A Battery Shim Installation

Before charging a spare battery, snap the MC75A shim into the battery slot as shown in [Figure 7-9](#).

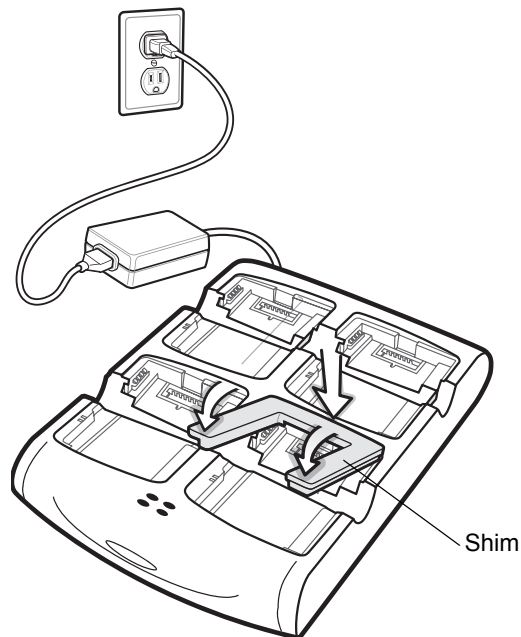

Figure 7-9 MC75A Battery Shim Installation

✓ **NOTE** To purchase additional shims, contact your local account manager or Zebra. Part number: KT-76490-01R.

Spare Battery Charging

1. Connect the charger to a power source.
2. Insert the spare battery into a spare battery charging well and gently press down on the battery to ensure proper contact.

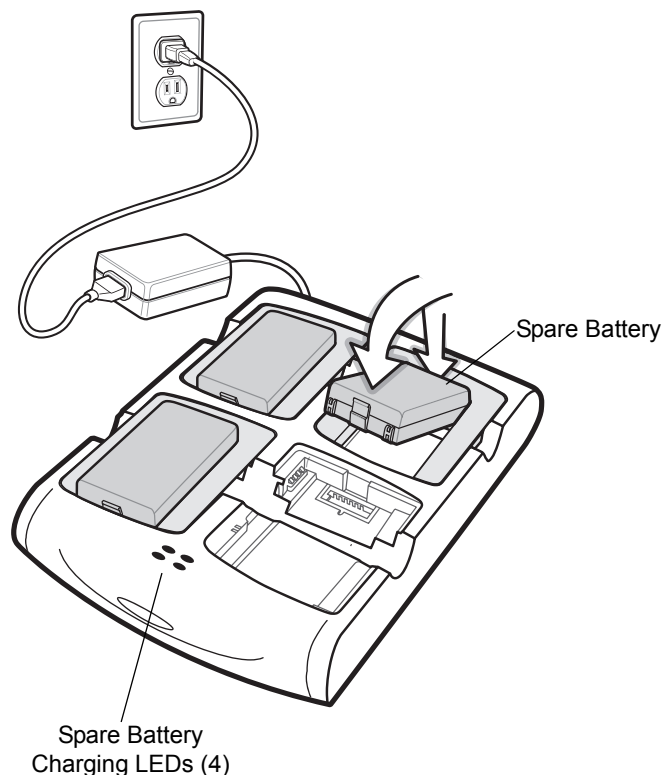

Figure 7-10 Four Slot Battery Charger

Battery Charging Indicators

The charger has an amber LED for each battery charging well. See [Table 7-4](#) for charging status indications. The 3600 mAh battery fully charges in less than five hours and the 4800 mAh battery fully charges in less than seven hours.

Charging Temperature

Charge batteries in temperatures from 0°C to 40°C (32°F to 104°F). Charging is intelligently controlled by the MC75A.

To accomplish this, for small periods of time, the charger alternately enables and disables battery charging to keep the battery at acceptable temperatures. The charger indicates when charging is disabled due to abnormal temperatures via its LED. See [Table 7-4](#).

Table 7-4 Spare Battery LED Charging Indicators

LED	Indication
Off	No spare battery in slot; battery is not charging; battery is not inserted correctly in the charger; charger is not powered.
Slow Blinking Amber	Spare battery is charging.
Solid Amber	Charging complete.
Fast Blinking Amber	Charging error.

Magnetic Stripe Reader (MSR)

This section describes how to set up and use the snap-on MSR with the MC75A. The MSR snaps on to the bottom of the MC75A and removes easily when not in use.

When attached to the MC75A, the MSR allows the MC75A to capture data from magnetic stripe cards. To download MSR data capture software, visit the Zebra web site at <http://www.zebra.com/support>.

With the MSR attach, the MC75A can still be charged by placing the MC75A with MSR into a cradle or connecting to a charging cable.

Attaching and Removing the MSR

To attach, slide the MSR onto the bottom of the MC75A and secure by snapping the arms into the MC75A housing.



Figure 7-11 MSR Installation

To remove the MSR open the arms and pull the MSR from the MC75A.

✓ **NOTE** When attaching a cable with a cup connector through the MSR to charge the device, you cannot swipe cards.

Using the MSR

Install an MSR enabled application onto the MC75A.

To use the MSR:

1. Attach the MSR to the MC75A.
2. Power on the MC75A.
3. Launch the MSR application.
4. Swipe the magnetic stripe card through the MSR, with the magnetic stripe on the card facing down. Swipe the card in either direction, from left to right or from right to left. For best results, gently press down on the card while swiping to ensure contact with the bottom of the reader.

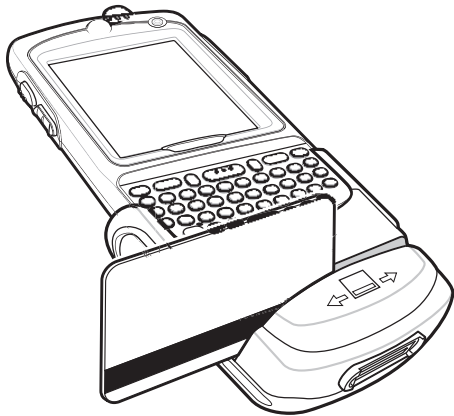

Figure 7-12 *Magnetic Stripe Card Swiping*

5. The application indicates if the data has been read correctly.

Debit Card Reader

The DCR7X00-100R Debit Card Reader (DCR) snaps onto the bottom of the MC70/MC75A mobile computer to allow easy data capture with the swipe of a magnetic stripe card and personal identification number (PIN) entry using a numeric keypad. This guide describes how to install and use the DCR.

Getting Started

When using the DCR for the first time, charge the DCR in a cradle for a minimum of three hours.

Installation

1. Align the DCR with the bottom of the MC75A and push up until the locking tabs snap into place.

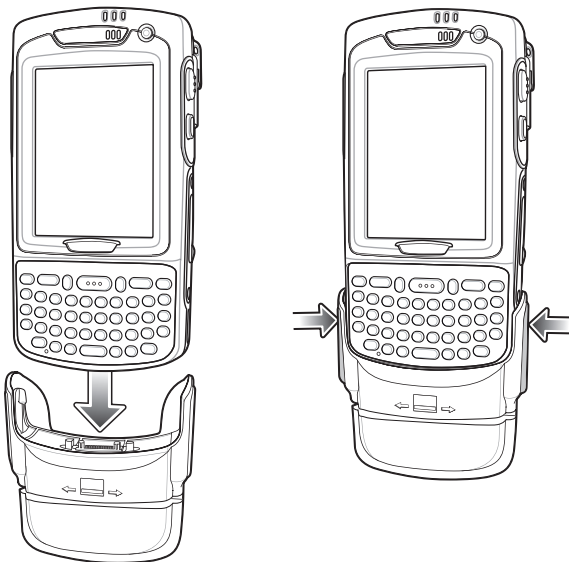

Figure 7-13 DCR Installation

2. Pull on the DCR to ensure it is securely connected to the MC75A.

Removal

To remove the DCR from the MC75A, push in the bottom of the two locking tabs and pull the DCR from the MC75A.

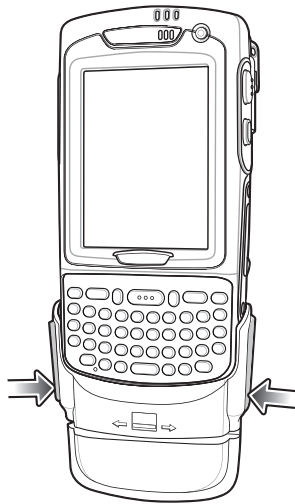

Figure 7-14 DCR Removal

Credit Card Transactions

Launch a transaction application on the MC75A. In the application, select Credit Card transaction.

Swipe the credit card through the magnetic stripe reader (MSR) slot, orienting the magnetic stripe as shown. Data encoded on the credit card is captured and, depending on the application, may display in an application data field.

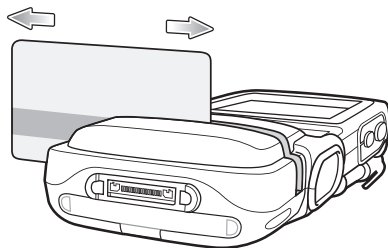

Figure 7-15 Swipe Card



NOTE Swipe the card in either direction, from left to right, or right to left. For best results, gently press down on the card while swiping to ensure contact with the bottom of the slot.

Debit Card Transactions

Launch a transaction application on the MC75A. In the application, select Debit Card transaction.

Swipe the debit card through the MSR slot, orienting the magnetic stripe as shown. Data encoded on the debit card is captured and, depending on the application, may display in an application data field.

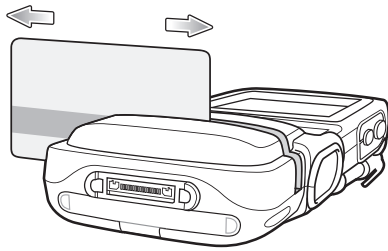

Figure 7-16 *Swipe Card*

- ✓ **NOTE** Swipe the card in either direction, from left to right, or right to left. For best results, gently press down on the card while swiping to ensure contact with the bottom of the slot.

Turn the MC75A over and present the DCR keypad to the customer. The customer enters their PIN following the instructions on the DCR display.



Figure 7-17 *Enter PIN on DCR*





Keypad

The back of the DCR contains a display and a numeric keypad for entering data.



Figure 7-18 *DCR Keypad*

Table 7-5 Keypad Key Descriptions

Key	Description
Numeric 	Used to enter PIN.
Cancel 	Cancels the current transaction.
Clear 	Clears the entered data.
Enter 	Submits the entered data.

Display Messages

The follow messages may appear on the DCR display:

ENTER PIN - A PIN is required to complete the transaction.

PIN ERR - The entered PIN is not between 4 and 12 characters.

CANCELED - The transaction was cancelled by the user.

COMPLETE - The transaction was completed.

KEYCLEAR - The DCR was tampered with or the battery completely discharged. The DCR must have the key re-injected. See your system administrator.

BATT OK - Battery is significantly charged.

BATT LOW - Battery charge is low. Re-charge as soon as possible.

STAND BY - DCR is performing a firmware check. This occurs if it has been powered off for more than 24 hours.

Check the DCR Battery Level

When the DCR is not used for extended periods of time or in storage it must be charged periodically to maintain the battery charge. Zebra recommends charging the DCR once every three months.

If the DCR battery fully discharges the debit function will be inoperable but the MSR will still function for credit card transactions. Return the DCR for service.

✓ **NOTE** While the DCR is being used in normal operation (application is accessing the DCR port), the DCR charges from the MC75A.

To check the battery level:

1. Remove the DCR from the MC75A.
2. Press and hold the **5** key until the battery status displays on the DCR display.
 - **BATT OK** - Battery is significantly charged

- **BATT LOW** - Battery charge is low.

If **BATT LOW** displays, charge the DCR for approximately three hours.

To charge the DCR, place it in a cradle or connect it to a charging cable. The DCR also charges when connected to the MC75A and the transaction application is running.

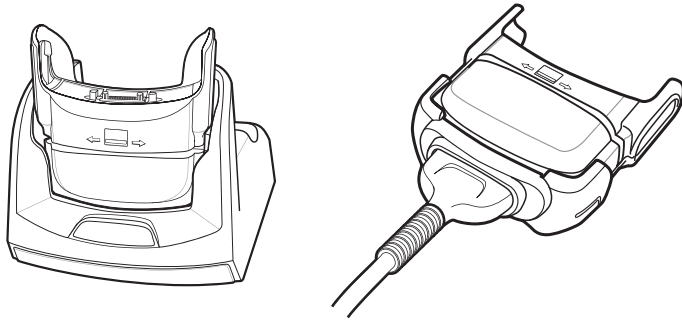

Figure 7-19 *Charging the DCR*

Snap-on Mobile Payment Module with Chip and PIN

The DCR7X00-200R Snap-on Mobile Payment Module with Chip and PIN smart card reader snaps onto the bottom of the MC75A mobile computer to allow easy data capture with magnetic stripe cards, EMV compliant Chip and PIN cards and personal identification number (PIN) entry using a numeric keypad. This guide describes how to install and use the module.

Installation

✓ **NOTE** The module only functions when attached to the MC70/MC75.

1. Align the module with the bottom of the MC75A and push up until the locking tabs snap into place.

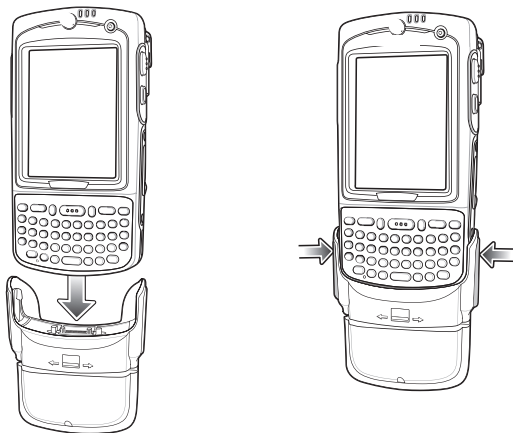

Figure 7-20 Attach Module to MC75A

2. Pull on the module to ensure it is securely connected to the MC75A.

Removal

To remove the module from the MC75A, push in the bottom of the two locking tabs and pull the module from the MC75A.

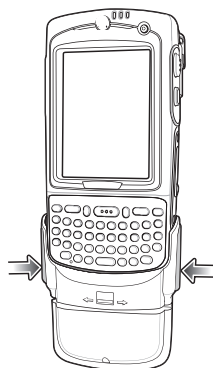

Figure 7-21 Press Latches In to Lock

Credit Card Transactions

- ✓ **NOTE** Credit Card transactions will function without an encryption key injected but will not function if a tamper event occurs.

Launch a transaction application on the MC75A. In the application, select Credit Card transaction.

Swipe the credit card through the magnetic stripe reader (MSR) slot, orienting the magnetic stripe as shown. Data encoded on the credit card is captured and, depending on the application, may display in an application data field.

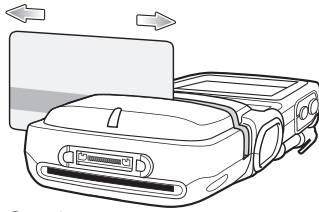

Figure 7-22 *Swipe Card*

- ✓ **NOTE** Swipe the card in either direction, from left to right, or right to left. For best results, gently press down on the card while swiping to ensure contact with the bottom of the slot.

Debit Card Transactions

- ✓ **NOTE** Debit Card transactions will only function with an encryption key injected. It will not function if a tamper event occurs.

Launch a transaction application on the MC75A. In the application, select Debit Card transaction.

Swipe the debit card through the MSR slot, orienting the magnetic stripe as shown. Data encoded on the debit card is captured and, depending on the application, may display in an application data field.

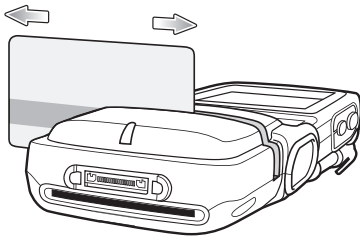

Figure 7-23 *Swipe Card*

- ✓ **NOTE** Swipe the card in either direction, from left to right, or right to left. For best results, gently press down on the card while swiping to ensure contact with the bottom of the slot.

Turn the MC75A over and present the keypad to the customer. The customer enters their PIN following the instructions on the display.



Figure 7-24 Enter PIN

Chip and PIN Transactions

- ✓ **NOTE** Chip and PIN transactions will function without an encryption key injected but will not function if a tamper event occurs.

Launch a transaction application on the MC75A. In the application, select Chip and PIN transaction.

Customer inserts the Chip and Pin card into the slot, orienting the card with the contacts facing down and toward the DCR keypad.

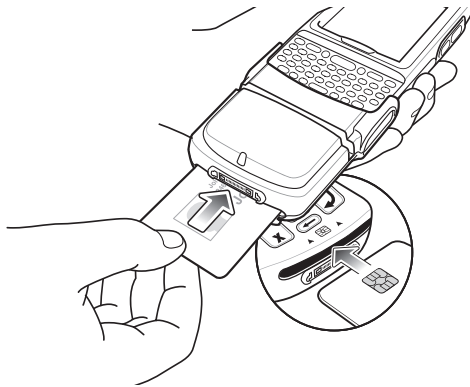

Figure 7-25 Insert Card

Customer turns the MC75A over, and enters their PIN following the instructions on the display.

Customer removes the card when transaction is complete.





Keypad

The back of the module contains a display and a numeric keypad for entering data.



Figure 7-26 Keypad

Table 7-6 Keypad Button Descriptions

Key	Description
Numeric 	Used to enter PIN.
Cancel (Red) 	Cancels the current transaction.
Clear (Yellow) 	Clears the entered data.
Enter (Green) 	Submits the entered data.

Display Messages

After connecting the module to the MC70/MC75 and an application opens the COM port, the following displays:



Figure 7-27 Display

Line 1 indicates the model number and the firmware version. The firmware version displays after the model number. In this example the firmware version is 0.09.

Line 2 indicates the keyload code. Each character of the keyload code represents a different key type.

Table 7-7 *Keyload Codes*

Display	Operating Status
D - - - - D M M - - D - - M M - M M - - - - - M M - - - - -	Normal
d - - - - d m m - - d - - m m - m m - - - - - m m	Return to key injection facility.
* * * * * Blank display	Return to Zebra for service.

The follow messages may appear on the display:

Table 7-8 *Display Messages*

Message	Description
Line 1: Line 2: Enter PIN	Instructs the user to enter their PIN.
Line 1: PIN Line 2: ENT to Accept	Displays "*" as PIN is entered and instructs the user to press enter key when done.

Headset

Use the headset to communicate via Voice-Over-IP (VOIP) or for audio playback and telephony applications. To connect the headset, remove the plug from the headset jack at the top of the MC75A and insert the headset connector. Contact a Zebra representative for compatible headsets.

For best performance, Zebra recommends a 2.5mm jack headset, p/n 50-11300-050R.

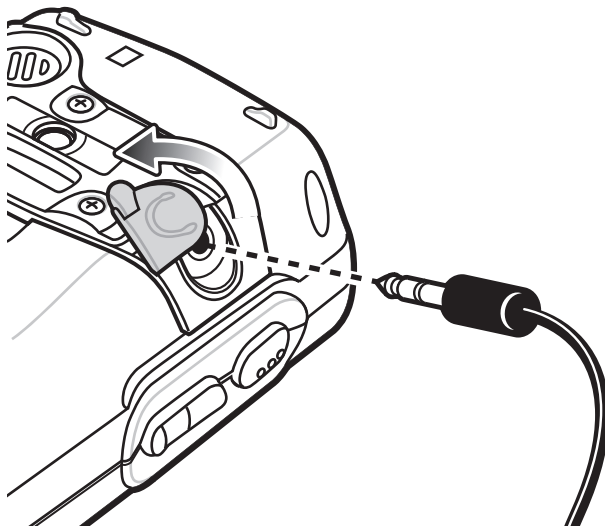

Figure 7-28 *Headset Connection*

Cables

This section describes how to set up and use the cables. The cables are available with a variety of connection capabilities.

The following communication/charge cables are available:

- Serial (RS232) Charge cable (9-pin D female with power input receptacle)
- USB Client Charge cable (standard-A connector and a barrel receptacle for power)
- Auto charge cable
- DEX cable
- Modem inverter cable
- Charge only cable.

The following printer cables are available directly from Zebra:

- O'Neil Printer cable
- Zebra Printer cable.

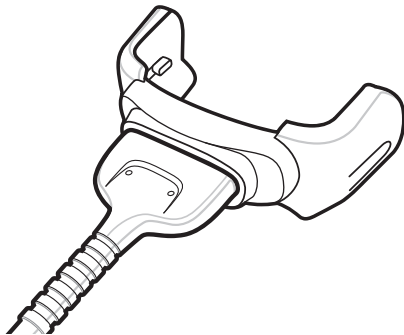

Figure 7-29 Cables

Communication/charge cables:

- Provide the MC75A with operating and charging power when used with the approved power supply.
- Synchronize information between the MC75A and a host computer. With customized or third party software, it can also synchronize the MC75A with corporate databases.
- Provide serial connection through the serial pass-through port for communication with a serial device, such as a host computer. For communication setup procedures, refer to the *MC75A Integrator Guide*.
- Provide USB connection through the USB pass-through port for communication with a USB device, such as a host computer. For communication setup procedures, refer to the *MC75A Integrator Guide*.

Dedicated printer cables provide communication with a printer.

Battery Charging and Operating Power

The communication/charge cables can charge the MC75A battery and supply operating power.

To charge the MC75A battery:

1. Connect the communication/charge cable power input connector to the approved power source.

2. Slide the bottom of the MC75A into the connector end of the communication/charge cable and gently press in until it latches into the MC75A. The MC75A amber Charge LED indicates the MC75A battery charging status. The 3600 mAh standard battery charges in less than five hours and the 4800 mAh standard battery charges in less than seven hours. See [Table 1-2 on page 1-7](#) for charging status indications.
3. When charging is complete, remove the cable by gently pulling the MC75A and the cable apart.

LED Charge Indications

The amber Charge LED on the MC75A indicates battery charging status. See [Table 1-2 on page 1-7](#) for charging status indications.

Charging Temperature

Charge batteries in temperatures from 0°C to 40°C (32°F to 104°F). Charging is intelligently controlled by the MC75A.

To accomplish this, for small periods of time, the MC75A or accessory alternately enables and disables battery charging to keep the battery at acceptable temperatures. The MC75A or accessory indicates when charging is disabled due to abnormal temperatures via its LED. See [Table 1-2 on page 1-7.4](#)

Chapter 8 Maintenance & Troubleshooting

Introduction

This chapter includes instructions on cleaning and storing the MC75A, and provides troubleshooting solutions for potential problems during MC75A operation.

Maintaining the MC75A

For trouble-free service, observe the following tips when using the MC75A:

- Do not scratch the screen of the MC75A. When working with the MC75A, use the supplied stylus or plastic-tipped pens intended for use with a touch-sensitive screen. Never use an actual pen or pencil or other sharp object on the surface of the MC75A screen.
- A screen protector, p/n KT-67525-01R, is applied to the MC75A. Zebra recommends using this to minimize wear and tear. Screen protectors enhance the usability and durability of touch screen displays. Benefits include:
 - Protection from scratches and gouges
 - Durable writing and touch surface with tactile feel
 - Abrasion and chemical resistance
 - Glare reduction
 - Keeping the device's screen looking new
 - Quick and easy installation.
- The touch-sensitive screen of the MC75A is glass. Do not to drop the MC75A or subject it to strong impact.
- Protect the MC75A from temperature extremes. Do not leave it on the dashboard of a car on a hot day, and keep it away from heat sources.
- Do not store or use the MC75A in any location that is dusty, damp, or wet.
- Use a soft lens cloth to clean the MC75A. If the surface of the MC75A screen becomes soiled, clean it with a soft cloth moistened with a diluted window-cleaning solution.
- Periodically replace the rechargeable battery to ensure maximum battery life and product performance. Battery life depends on individual usage patterns.

Removing the Screen Protector

A screen protector is applied to the MC75A. Zebra recommends using this to minimize wear and tear. Screen protectors enhance the usability and durability of touch screen displays.

To remove the screen protector, lift the corner using a thin plastic card, such as a credit card, then carefully lift it off the display.

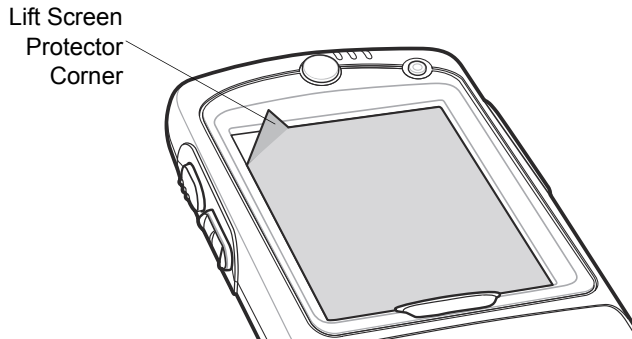

Figure 8-1 Removing the Screen Protector



CAUTION Do not use a sharp object to remove the protector. Doing so can damage the display.



NOTE Not using a screen protector can affect warranty coverage. To purchase replacement protectors, contact your local account manager or Zebra. These include screen protector installation instructions. Part number: KT-67525-01R Screen Protector 3/pk.

Battery Safety Guidelines

- The area in which the units are charged should be clear of debris and combustible materials or chemicals. Particular care should be taken where the device is charged in a non commercial environment.
- Follow battery usage, storage, and charging guidelines found in the user's guide.
- Improper battery use may result in a fire, explosion, or other hazard.
- To charge the mobile device battery, the battery and charger temperatures must be between +32 °F and +104 °F (0 °C and +40 °C)
- Do not use incompatible batteries and chargers. Use of an incompatible battery or charger may present a risk of fire, explosion, leakage, or other hazard. If you have any questions about the compatibility of a battery or a charger, contact Zebra support.
- For devices that utilize a USB port as a charging source, the device shall only be connected to products that bear the USB-IF logo or have completed the USB-IF compliance program.
- To enable authentication of an approved battery, as required by IEEE1725 clause 10.2.1, all batteries will carry a Zebra hologram. Do not fit any battery without checking it has the Zebra authentication hologram.
- Do not disassemble or open, crush, bend or deform, puncture, or shred.

- Severe impact from dropping any battery-operated device on a hard surface could cause the battery to overheat.
- Do not short circuit a battery or allow metallic or conductive objects to contact the battery terminals.
- Do not modify or remanufacture, attempt to insert foreign objects into the battery, immerse or expose to water or other liquids, or expose to fire, explosion, or other hazard.
- Do not leave or store the equipment in or near areas that might get very hot, such as in a parked vehicle or near a radiator or other heat source. Do not place battery into a microwave oven or dryer.
- Battery usage by children should be supervised.
- Please follow local regulations to promptly dispose of used re-chargeable batteries.
- Do not dispose of batteries in fire.
- Seek medical advice immediately if a battery has been swallowed.
- In the event of a battery leak, do not allow the liquid to come in contact with the skin or eyes. If contact has been made, wash the affected area with large amounts of water and seek medical advice.
- If you suspect damage to your equipment or battery, contact Zebra support to arrange for inspection.

Cleaning



WARNING! Avoid exposing this product to contact with hot oil or other flammable liquids. If such exposure occurs, unplug the device and clean the product immediately in accordance with these guidelines.



CAUTION Always wear eye protection.

Read warning label on compressed air and alcohol product before using.

If you have to use any other solution for medical reasons please contact Zebra for more information.

Materials Required

- Alcohol wipes
- Lens tissue
- Cotton tipped applicators
- Isopropyl alcohol
- Can of compressed air with a tube.

Cleaning the MC75A

Housing

Using the alcohol wipes, wipe the housing including keys and in-between keys.

Display

The display can be wiped down with the alcohol wipes, but care should be taken not to allow any pooling of liquid around the edges of the display. Immediately dried the display with a soft, non-abrasive cloth to prevent streaking.

Scanner Exit Window

Wipe the scanner exit window periodically with a lens tissue or other material suitable for cleaning optical material such as eyeglasses.

Connector

1. Remove the main battery from mobile computer. See [Replacing the Main Battery on page 1-9](#).
2. Close battery door.
3. Dip the cotton portion of the cotton tipped applicator in isopropyl alcohol.
4. Rub the cotton portion of the cotton tipped applicator back-and-forth across the connector on the bottom of the MC75A. Do not leave any cotton residue on the connector.
5. Repeat at least three times.
6. Use the cotton tipped applicator dipped in alcohol to remove any grease and dirt near the connector area.
7. Use a dry cotton tipped applicator and repeat steps 4 through 6.



CAUTION Do not point nozzle at yourself and others, ensure the nozzle or tube is away from your face.

8. Spray compressed air on the connector area by pointing the tube/nozzle about ½ inch away from the surface.
9. Inspect the area for any grease or dirt, repeat if required.

Cleaning Cradle Connectors

To clean the connectors on a cradle:

1. Remove the DC power cable from the cradle.
2. Dip the cotton portion of the cotton tipped applicator in isopropyl alcohol.
3. Rub the cotton portion of the cotton tipped applicator along the pins of the connector. Slowly move the applicator back-and-forth from one side of the connector to the other. Do not let any cotton residue on the connector.
4. All sides of the connector should also be rubbed with the cotton tipped applicator.



CAUTION Do not point nozzle at yourself and others, ensure the nozzle or tube is away from your face.

5. Spray compressed air in the connector area by pointing the tube/nozzle about ½ inch away from the surface.
6. Ensure that there is no lint left by the cotton tipped applicator, remove lint if found.
7. If grease and other dirt can be found on other areas of the cradle, use lint free cloth and alcohol to remove.
8. Allow at least 10 to 30 minutes (depending on ambient temperature and humidity) for the alcohol to air dry before applying power to cradle.

If the temperature is low and humidity is high, longer drying time is required. Warm temperature and dry humidity requires less drying time.

Cleaning Frequency

The cleaning frequency is up to the customer's discretion due to the varied environments in which the mobile devices are used. They may be cleaned as frequently as required. However when used in dirty environments it may be advisable to periodically clean the scanner exit window to ensure optimum scanning performance.

Troubleshooting

MC75A

Table 8-1 Troubleshooting the MC75A

Problem	Cause	Solution
MC75A does not turn on.	Battery not charged.	Charge or replace the battery.
	Battery not installed properly.	Install the battery properly. See Installing the Main Battery on page 1-4 .
	System crash.	Perform a warm boot. If the MC75A still does not turn on, perform a cold boot. See Resetting the MC75A on page 2-17 .
Rechargeable battery did not charge.	Battery failed.	Replace battery. If the MC75A still does not operate, perform a warm boot, then a cold boot. See Resetting the MC75A on page 2-17 .
	MC75A removed from cradle while battery was charging.	Insert MC75A in cradle and allow to charge.
	Extreme battery temperature.	Battery does not charge if ambient temperature is below 0°C (32°F) or above 40°C (104°F).
Cannot see characters on display.	MC75A not powered on.	Press the red Power button.
During data communication, no data transmitted, or transmitted data was incomplete.	MC75A removed from cradle or disconnected from host computer during communication.	Replace the MC75A in the cradle, or reattach the communication cable and re-transmit.
	Incorrect cable configuration.	See the system administrator.
	Communication software was incorrectly installed or configured.	Perform setup. Refer to the <i>MC75A Enterprise Digital Assistant Integrator Guide</i> for details.
No sound.	Volume setting is low or turned off.	Adjust the volume. See Adjusting Volume on page 2-12 .

Table 8-1 Troubleshooting the MC75A (Continued)

Problem	Cause	Solution
MC75A shuts off.	MC75A is inactive.	The MC75A turns off after a period of inactivity. If the MC75A is running on battery power, set this period from 1 to 5 minutes, in one-minute intervals. If the MC75A is running on external power, set this period to 1, 2, 5, 10, 15, or 30 minutes. Check the Power window by selecting Start > Settings > Power icon. Select the Advanced tab and change the setting for a longer delay before the automatic shutoff feature activates.
	Battery is depleted.	Recharge or replace the battery.
	Battery is not inserted properly.	Insert the battery properly. See Installing the Main Battery on page 1-4 .
Tapping the window buttons or icons does not activate the corresponding feature.	Screen is not calibrated correctly.	Re-calibrate the screen. See Calibrating the Screen on page 1-7 .
	The system is not responding.	Warm boot the system. See Resetting the MC75A on page 2-17 .
A message appears stating that the MC75A memory is full.	Too many files stored on the MC75A.	Delete unused memos and records. If necessary, save these records on the host computer (or use an SD card for additional memory).
	Too many applications installed on the MC75A.	Remove user-installed applications on the MC75A to recover memory. Select Start > Settings > System and tap the Remove Programs icon. Select the unused program and tap Remove .
MC75A keeps powering down to protect memory contents.	The MC75A's battery is low.	Recharge or replace the battery. Configure the MC75A to conserve power. Refer to Battery Management on page 1-11 for more information.

Table 8-1 *Troubleshooting the MC75A (Continued)*

Problem	Cause	Solution
The MC75A does not accept data capture input.	Scanning application is not loaded.	Load a scanning application on the MC75A. See the system administrator.
	Unreadable bar code.	Ensure the symbol is not defaced.
	Distance between exit window and bar code is incorrect.	Place the MC75A within proper scanning range.
	MC75A is not programmed for the bar code.	Program the MC75A to accept the type of bar code being scanned.
	MC75A is not programmed to generate a beep.	If the MC75A does not beep on a good decode, set the application to generate a beep on good decode.
	Battery is low.	If the scanner stops emitting a laser beam upon a trigger press, check the battery level. When the battery is low, the scanner shuts off before the MC75A low battery condition notification. Note: If the scanner is still not reading symbols, contact the distributor or Zebra.

Bluetooth Connection

Table 8-2 *Troubleshooting Bluetooth Connection*

Problem	Cause	Solution
MC75A cannot find any Bluetooth devices nearby.	Too far from other Bluetooth devices.	Move closer to the other Bluetooth device(s), within a range of 10 meters.
	The Bluetooth device(s) nearby are not turned on.	Turn on the Bluetooth device(s).
	The Bluetooth device(s) are not in discoverable mode.	Set the Bluetooth device(s) to discoverable mode. If needed, refer to the device's user documentation for help.

Table 8-2 *Troubleshooting Bluetooth Connection (Continued)*

Problem	Cause	Solution
When trying to connect a Bluetooth device and the MC75A, the device thinks a previously paired MC75A is used.	The device remembers the name and address of the MC75A it last paired with via the Bluetooth radio.	Manually delete the pairing device and name from the device. Refer to the device's user documentation for instructions.
There is a delay in the Bluetooth stack re-initializing during a resume from suspend.	This is normal behavior.	No solution required.
The Bluetooth connection drops.	The MC75A suspends and the Bluetooth radio power turns off.	When the MC75A suspends the Bluetooth connection is dropped. Re-connect the Bluetooth connection when the MC75A returns from suspend mode.

Single Slot USB/Serial Cradle

Table 8-3 *Troubleshooting the Single Slot USB/Serial Cradle*

Symptom	Possible Cause	Action
LEDs do not light when MC75A or spare battery is inserted.	Cradle is not receiving power.	Ensure the power cable is connected securely to both the cradle and to AC power.
	MC75A is not seated firmly in the cradle.	Remove and re-insert the MC75A into the cradle, ensuring it is firmly seated.
	Spare battery is not seated firmly in the cradle.	Remove and re-insert the spare battery into the charging slot, ensuring it is firmly seated.

Table 8-3 Troubleshooting the Single Slot USB/Serial Cradle (Continued)

Symptom	Possible Cause	Action
MC75A battery is not charging.	MC75A was removed from cradle or cradle was unplugged from AC power too soon.	Ensure cradle is receiving power. Ensure MC75A is seated correctly. Confirm main battery is charging under Start > Settings > Power .
	Battery is faulty.	Verify that other batteries charge properly. If so, replace the faulty battery.
	The MC75A is not fully seated in the cradle.	Remove and re-insert the MC75A into the cradle, ensuring it is firmly seated.
	Ambient temperature of the cradle is too warm.	Move the cradle to an area where the ambient temperature is between 0°C (32°F) and 35°C (95°F).
	Extreme battery temperature.	Battery does not charge if ambient temperature is below 0°C (32°F) or above 40°C (104°F).
Spare battery is not charging.	Spare battery inserted incorrectly.	Re-insert the spare battery so the charging contacts on the battery align with the contacts on the cradle.
	Spare battery is faulty.	Verify that other batteries charge properly. If so, replace the faulty battery.
	Ambient temperature of the cradle is too warm.	Move the cradle to an area where the ambient temperature is between 0°C (32°F) and 35°C (95°F).
During data communication, no data transmits, or transmitted data was incomplete.	MC75A removed from cradle during communications.	Replace MC75A in cradle and retransmit.
	Incorrect cable configuration.	See the system administrator.
	Communication software is not installed or configured properly.	Perform setup as described in the <i>MC75A Enterprise Digital Assistant Integrator Guide</i> .

Four Slot Ethernet Cradle

Table 8-4 *Troubleshooting the Four Slot Ethernet Cradle*

Symptom	Cause	Solution
During communication, no data transmits, or transmitted data was incomplete.	MC75A was removed from cradle during communications.	Replace MC75A in cradle and retransmit.
	MC75A has no active connection.	An icon is visible in the status bar if a connection is currently active.
Battery is not charging.	MC75A removed from the cradle too soon.	Replace the MC75A in the cradle. Tap Start > Settings > Power to view battery status.
	Battery is faulty.	Verify that other batteries charge properly. If so, replace the faulty battery.
	MC75A is not inserted correctly in the cradle.	Remove the MC75A and reinsert it correctly. Verify charging is active. Tap Start > Settings > Power to view battery status.
	Ambient temperature of the cradle is too warm.	Move the cradle to an area where the ambient temperature is between 0°C (32°F) and 35°C (95°F).

Vehicle Cradle

Table 8-5 *Troubleshooting the Vehicle Cradle*

Symptom	Possible Cause	Action
MC75A battery charging LED does not light up.	Cradle is not receiving power.	Ensure the power input cable is securely connected to the cradle's power port.
MC75A battery is not recharging.	MC75A was removed from the cradle too soon.	Replace the MC75A in the cradle.
	Battery is faulty.	Replace the battery.
	MC75A is not placed correctly in the cradle.	Remove the MC75A from the cradle, and re-insert correctly. If the battery still does not charge, contact customer support. The MC75A battery charging LED slowly blinks amber when the MC75A is correctly inserted and charging.
	Ambient temperature of the cradle is too warm.	Move the cradle to an area where the ambient temperature is between 0°C (32°F) and 35°C (95°F).

Table 8-5 *Troubleshooting the Vehicle Cradle*

Symptom	Possible Cause	Action
No data transmitted, or transmitted data was incomplete.	MC75A removed from cradle during communication.	Replace MC75A in cradle and retransmit.
	No null modem cable was used.	Some external devices require a null modem cable. Retransmit using a null modem cable.
	Incorrect cable configuration.	See the system administrator.
	Cable missing or disconnected.	Re-connect cable.

Four Slot Battery Charger

Table 8-6 *Troubleshooting The Four Slot Battery Charger*

Symptom	Possible Cause	Action
Battery not charging.	Battery was removed from the charger or charger was unplugged from AC power too soon.	Re-insert the battery in the charger or re-connect the charger's power supply.
	Battery is faulty.	Verify that other batteries charge properly. If so, replace the faulty battery.
	Battery contacts not connected to charger.	Verify that the battery is seated in the battery well correctly with the contacts facing down.
	Ambient temperature of the cradle is too warm.	Move the cradle to an area where the ambient temperature is between 0°C (32°F) and 35°C (95°F).

Cables

Table 8-7 *Troubleshooting the Cables*

Symptom	Possible Cause	Action
MC75A battery is not charging.	MC75A was disconnected from AC power too soon.	Connect the power cable correctly. Confirm main battery is charging under Start > Settings > Power .
	Battery is faulty.	Verify that other batteries charge properly. If so, replace the faulty battery.
	The MC75A is not fully attached to power.	Detach and re-attach the power cable to the MC75A, ensuring it is firmly connected.
During data communication, no data transmits, or transmitted data was incomplete.	Cable was disconnected from MC75A during communications.	Re-attach the cable and retransmit.
	Incorrect cable configuration.	See the system administrator.
	Communication software is not installed or configured properly.	Perform setup as described in the <i>MC75A Integrator Guide</i> .

Magnetic Stripe Reader

Table 8-8 *Troubleshooting the Magnetic Stripe Reader*

Symptom	Possible Cause	Action
MSR cannot read card.	MSR removed from MC75A during card swipe.	Reattach MSR to MC75A and reswipe the card.
	Faulty magnetic stripe on card.	See the system administrator.
	MSR application is not installed or configured properly.	Ensure the MSR application is installed on the MC75A. Ensure the MSR application is configured correctly.

Table 8-8 Troubleshooting the Magnetic Stripe Reader (Continued)

Symptom	Possible Cause	Action
MC75A battery is not charging.	MC75A was removed from MSR or MSR was unplugged from AC power too soon.	Ensure MSR is receiving power. Ensure MC75A is attached correctly. Confirm main battery is charging under Start > Settings > Power .
	Battery is faulty.	Verify that other batteries charge properly. If so, replace the faulty battery.
	The MC75A is not fully attached to the MSR.	Detach and re-attach the MSR to the MC75A, ensuring it is firmly connected.
During data communication, no data transmits, or transmitted data was incomplete.	MC75A detached from MSR during communications.	Reattach MC75A to MSR and retransmit.
	Incorrect cable configuration.	See the system administrator.
	Communication software is not installed or configured properly.	Perform setup as described in the <i>MC75A Integrator Guide</i> .

Appendix A Technical Specifications

MC75A Technical Specifications

The following tables summarize the MC75A's intended operating environment and technical hardware specifications.

MC75A

Table A-1 MC75A Technical Specifications

Item	Description
Physical Characteristics	
Dimensions	MC75A0: Length: 15.2 cm (6.00 in.) Width: 8.4 cm (3.30 in.) Depth: 4.4 cm (1.70 in.) MC75A6/8: Length: 17.78 cm (7.0 in.) Width: 8.4 cm (3.30 in.) Depth: 4.4 cm (1.70 in.)
Weight	MC75A0: 364 g (12.84 oz) - with 1950 mAh battery 398g (14.04 oz) - with 3600 mAh battery MC75A6/8: 389 g (13.72 oz) - with 1950 mAh battery 423 g (14.92 oz) - with 3600 mAh battery
Display	Transflective color 3.5" VGA with backlight, TFT-LCD, 65K colors, 480 W x 640 L (VGA size)
Touch Panel	Glass analog resistive touch

Note 1: Total output power can be either USB or serial or a combination of both that cannot exceed 200 mA.

Table A-1 MC75A Technical Specifications (Continued)

Item	Description
Backlight	LED backlight
Main Battery	Rechargeable Lithium Ion 3.7V, 1950, 3600 or 4800 mAh Smart Battery
Backup Battery	NiMH battery (rechargeable) 15 mAh 2.4V (not user-accessible)
Expansion Slot	User accessible microSD slot with SDHC support (with secure cover).
Network Connections	Ethernet (via cradle) Full-speed USB, host or client, Bluetooth
Notification	Vibrator and LED
Keypad Options	Numeric, DSD, QWERTY, AZERTY and QWERTZ
Audio	VoWWAN; VoWLAN; TEAM Express compliant; support for wired and wireless (Bluetooth) headsets; headset, handset and speaker phone modes
Performance Characteristics	
CPU	Marvell PXA320 processor at 806 MHz
Operating System	MC75A0: Microsoft® Windows Mobile™ 6.5 Classic MC75A6/8: Microsoft® Windows Mobile™ 6.5 Professional
Memory	256MB RAM/1GB FLASH
Interface/Communications	RS-232, USB 1.1, IrDA
Output Power (Note 1)	USB: 5 VDC @ 200 mA max. Serial: 5 VDC @ 200 mA max.
User Environment	
Operating Temperature	-10°C to 50°C (14°F to 122°F)
Storage Temperature	-40°C to 70°C (-40°F to 158°F) - without battery
Charging Temperature	32°F to 104°F / 0° C to 40° C
Humidity	95% non-condensing
Drop Specification	Multiple 1.5 m (5 ft.) drop to concrete, at room temperature 23°C (73°F). Multiple 1.2 m (4 ft.) drop to concrete, over operating temperature range. Meets and exceeds applicable MIL-STD 810G specifications.
Tumble	1,000 0.5 m (1.6 ft.) tumbles (2,000 drops); per applicable IEC tumble specifications.
Electrostatic Discharge (ESD)	+/-15kVdc air discharge, +/-8kVdc direct discharge, +/-8kVdc indirect discharge
Sealing	IP54 per applicable IEC sealing specifications.

Note 1: Total output power can be either USB or serial or a combination of both that cannot exceed 200 mA.

Table A-1 MC75A Technical Specifications (Continued)

Item	Description
Wireless WAN Data and Voice Communications	
Wireless Wide Area Network (WWAN) radios	MC75A6: GSM: HSDPA (850, 900, 1800, 1900 and 2100 MHz) MC75A8: CDMA: EVDO Rev A (800 and 1900 MHz)
GPS	Integrated, Autonomous and Assisted-GPS (A-GPS) through SUPL; SiRFstarIII GSC3f/LP choppiest.
Wireless LAN Data and Voice Communications	
Wireless Local Area Network (WLAN) radio	Tri-mode IEEE [®] 802.11a/b/g
Data Rates Supported	1, 2, 5.5, 6, 9, 11, 12, 18, 24, 36, 48, and 54 Mbps
Operating Channels	Chan 8-169 (5040 – 5845 MHz) Chan 1-13 (2412-2472 MHz) Chan 14 (2484 MHz) Japan only Actual operating frequencies depend on regulatory rules and certification agency
Security	WPA2, WEP (40 or 128 bit), TKIP, TLS, TTLS (MS-CHAP), TTLS (MS-CHAP v2), TTLS (CHAP), TTLS-MD5, TTLS-PAP, PEAP-TLS, PEAP (MS-CHAP v2), AES, LEAP, CCXv4 certified; FIPS 140-2 certified
Spreading Technique	Direct Sequence Spread Spectrum (DSSS) and Orthogonal Frequency Division Multiplexing (OFDM)
Antenna	Internal for WLAN and Bluetooth
Voice Communication	Integrated Voice-over-IP ready (P2P, PBX, PTT), Wi-Fi™-certified, IEEE 802.11a/b/g direct sequence wireless LAN
Wireless PAN Data and Voice Communications	
Bluetooth	Class II, v 2.1 with EDR; on-board chip antenna.
Data Capture Specifications	
Options	2D imager, 1D linear, color camera
Linear 1D Scanner (SE950) Specifications	
Optical Resolution	0.005 in. minimum element width
Roll	+/- 30° from vertical
Pitch Angle	+/- 65° from normal
Skew Tolerance	+/- 60° from normal
Ambient Light	Sunlight: 8,000 ft. candles (86,112 Lux) Artificial Light: 450 ft. candles (4,844 Lux)
Shock	2,000 +/- 5% G

Note 1: Total output power can be either USB or serial or a combination of both that cannot exceed 200 mA.

Table A-1 MC75A Technical Specifications (Continued)

Item	Description
Scan Rate	50 (+/- 6) scans/sec (bidirectional)
Scan Angle	46.5° (typical)
Laser Power	1.0 mW nominal
2D Imager Engine (SE4500) Specifications	
Field of View	Horizontal - 40° Vertical - 25°
Optical Resolution	752X 480 V pixels (gray scale)
Roll	360°
Pitch Angle	+/- 60° from normal
Skew Tolerance	+/- 60° from normal
Ambient Light	9,000 ft. candles (96,900 Lux)
Shock	2,000 +/- 5% G
Focal Distance from Front of Engine	Near: 5 inches Far: 9 inches
Aiming Element (VLD)	655 nm +/- 10 nm
Illumination Element (LED)	625 nm +/- 5 nm
Camera Specifications	
Resolution	2 Mega pixel with auto focus and flash

Note 1: Total output power can be either USB or serial or a combination of both that cannot exceed 200 mA.

Table A-2 Data Capture Options

Item	Description																											
Laser Decode Capability	<table border="0"> <tr> <td>Code 39</td> <td>Code 128</td> <td>Code 93</td> </tr> <tr> <td>Codabar</td> <td>Code 11</td> <td>Discrete 2 of 5</td> </tr> <tr> <td>Interleaved 2 of 5</td> <td>EAN-8</td> <td>EAN-13</td> </tr> <tr> <td>MSI</td> <td>UPCA</td> <td>UPCE</td> </tr> <tr> <td>UPC/EAN supplementals</td> <td>Coupon Code</td> <td>Trioptic 39</td> </tr> <tr> <td>Webcode</td> <td>Chinese 2 of 5</td> <td>GS1 DataBar</td> </tr> <tr> <td>GS1 DataBar Truncated</td> <td>GS1 DataBar Limited</td> <td>GS1 DataBar Stacked</td> </tr> <tr> <td>GS1 DataBar Expanded</td> <td>GS1 DataBar Expanded Stacked</td> <td></td> </tr> <tr> <td>GS1 DataBar Stacked Omni</td> <td></td> <td></td> </tr> </table>	Code 39	Code 128	Code 93	Codabar	Code 11	Discrete 2 of 5	Interleaved 2 of 5	EAN-8	EAN-13	MSI	UPCA	UPCE	UPC/EAN supplementals	Coupon Code	Trioptic 39	Webcode	Chinese 2 of 5	GS1 DataBar	GS1 DataBar Truncated	GS1 DataBar Limited	GS1 DataBar Stacked	GS1 DataBar Expanded	GS1 DataBar Expanded Stacked		GS1 DataBar Stacked Omni		
Code 39	Code 128	Code 93																										
Codabar	Code 11	Discrete 2 of 5																										
Interleaved 2 of 5	EAN-8	EAN-13																										
MSI	UPCA	UPCE																										
UPC/EAN supplementals	Coupon Code	Trioptic 39																										
Webcode	Chinese 2 of 5	GS1 DataBar																										
GS1 DataBar Truncated	GS1 DataBar Limited	GS1 DataBar Stacked																										
GS1 DataBar Expanded	GS1 DataBar Expanded Stacked																											
GS1 DataBar Stacked Omni																												

Table A-2 *Data Capture Options (Continued)*

Item	Description		
Imaging Decode Capability	Code 39 Codabar Discrete 2 of 5 EAN-13 UPC/EAN supplementals Webcode Composite C Macro PDF-417 Data Matrix US Planet Canadian 4-state Chinese 2 of 5 microQR GS1 DataBar Limited GS1 DataBar Expanded Stacked	Code 128 Code 11 MSI UPCA Coupon Code TLC39 Micro PDF-417 (Macro) Micro PDF-417 Maxi Code UK 4-state Japanese 4-state USPS 4-state (US4CB) GS1 DataBar GS1 DataBar Stacked GS1 DataBar Stacked Omni	Code 93 Interleaved 2 of 5 EAN-8 UPCE Trioptic 39 Composite AB PDF-417 QR Code US Postnet* Australian 4-state Dutch Kix Aztec GS1 DataBar Truncated GS1 DataBar Expanded
Camera Decode Capability	Code 39 Codabar Discrete 2 of 5 EAN-13 UPC/EAN supplementals Webcode Composite C Macro PDF-417 Data Matrix US Planet Canadian 4-state GS1 DataBar GS1 DataBar Stacked Expanded Stacked	Code 128 Code 11 MSI UPCA Coupon Code TLC39 Micro PDF-417 (Macro) Micro PDF-417 Maxi Code UK 4-state Japanese 4-state GS1 DataBar Truncated GS1 DataBar Expanded GS1 DataBar Stacked Omni	Code 93 Interleaved 2 of 5 EAN-8 UPCE Trioptic 39 Composite AB PDF-417 QR Code US Postnet* Australian 4-state Dutch Kix GS1 DataBar Limited GS1 DataBar

MC75A Accessory Specifications

Single Slot USB/Serial Cradle

Table A-3 *Single Slot USB/Serial Cradle Technical Specifications*

Feature	Description
Dimensions	Length: 14.54 cm (5.72 in.) Width: 11.05 cm (4.35 in.) Height: 9.10 cm (3.58 in.)
Weight	196 g (6.9 oz)
Input Power	12 VDC
Power Consumption	30 watts
Interface	USB, Serial
Operating Temperature	0°C to 50°C (32°F to 122°F)
Storage Temperature	-40°C to 70°C (-40°F to 158°F)
Charging Temperature	0°C to 40°C (32°F to 104°F)
Humidity	5% to 95% non-condensing
Drop	76.2 cm (30.0 in.) drops to vinyl tiled concrete at room temperature
Electrostatic Discharge (ESD)	+/- 15 kV air +/- 8 kV contact

Four Slot Ethernet Cradle

Table A-4 *Four Slot Ethernet Cradle Technical Specifications*

Feature	Description
Dimensions	Length: 46.80 cm (18.42 in.) Width: 10.90 cm (4.29 in.) Height: 13.70 cm (5.39 in.)
Weight	1079 g (2.38 lb)
Input Power	12 VDC
Power Consumption	100 watts
Interface	Ethernet
Operating Temperature	0°C to 50°C (32°F to 122°F)
Storage Temperature	-40°C to 70°C (-40°F to 158°F)

Table A-4 *Four Slot Ethernet Cradle Technical Specifications (Continued)*

Feature	Description
Charging Temperature	0°C to 40°C (32°F to 104°F)
Humidity	5% to 95% non-condensing
Drop	76.2 cm (30.0 in.) drops to vinyl tiled concrete at room temperature
Electrostatic Discharge (ESD)	+/- 15 kV air +/- 8 kV contact

Four Slot Charge Only Cradle

Table A-5 *Four Slot Charge Only Cradle Technical Specifications*

Feature	Description
Dimensions	Length: 46.80 cm (18.42 in.) Width: 10.90 cm (4.29 in.) Height: 13.70 cm (5.39 in.)
Weight	1079 g (2.38 lb)
Input Power	12 VDC
Power Consumption	100 watts
Operating Temperature	0°C to 50°C (32°F to 122°F)
Storage Temperature	-40°C to 70°C (-40°F to 158°F)
Charging Temperature	0°C to 40°C (32°F to 104°F)
Humidity	5% to 95% non-condensing
Drop	76.2 cm (30.0 in.) drops to vinyl tiled concrete at room temperature
Electrostatic Discharge (ESD)	+/- 15 kV air +/- 8 kV contact

Four Slot Battery Charger

Table A-6 *Four Slot Battery Charger Technical Specifications*

Feature	Description
Dimensions	Length: 21.0 cm (8.27 in.) Width: 15.50 cm (6.10 in.) Height: 3.47 cm (1.37 in.)
Weight	386 g (13.6 oz)
Input Power	12 VDC

Table A-6 Four Slot Battery Charger Technical Specifications (Continued)

Feature	Description
Power Consumption	30 watts
Operating Temperature	0°C to 50°C (32°F to 122°F)
Storage Temperature	-40°C to 70°C (-40°F to 158°F)
Charging Temperature	0°C to 40°C (32°F to 104°F)
Humidity	5% to 95% non-condensing
Drop	76.2 cm (30.0 in.) drops to vinyl tiled concrete at room temperature
Electrostatic Discharge (ESD)	+/- 15 kV air +/- 8 kV contact

Magnetic Stripe Reader

Table A-7 Magnetic Stripe Reader (MSR) Technical Specifications

Feature	Description
Dimensions	Length: 7.87 cm (3.1 in.) Width: 8.38 cm (3.3 in.) Height: 3.56 cm (1.4 in.)
Weight	48 g (1.7 oz)
Interface	Serial with baud rate up to 19,200
Format	ANSI, ISO, AAMVA, CA DMV, user-configurable generic format
Swipe Speed	5 to 50 in. (127 to 1270 mm) /sec, bi-directional
Decoders	Generic, Raw Data
Mode	Buffered, unbuffered
Track Reading Capabilities	Tracks 1 and 3: 210 bpi Track 2: 75 and 210 bpi, autodetect
Operating Temperature	0°C to 50°C (32°F to 122°F)
Storage Temperature	-40°C to 70°C (-40°F to 158°F)
Humidity	5% to 95% non-condensing
Drop	1.22 m (4 ft.) drops to concrete
Electrostatic Discharge (ESD)	+/- 15 kV air +/- 8 kV contact

Appendix B Keypads

Introduction

The MC75A offers five types of keypad configurations: Numeric, DSD, QWERTY, AZERTY and QWERTZ.

Numeric Keypad Configuration

The numeric keypad contains application keys, scroll keys, and function keys. The keypad is color-coded to indicate the alternate function key (blue) values. Note that an application can change keypad functions so the MC75A's keypad may not function exactly as described. See [Table B-1](#) for key and button descriptions and [Table B-2 on page B-4](#) for the keypad's special functions.

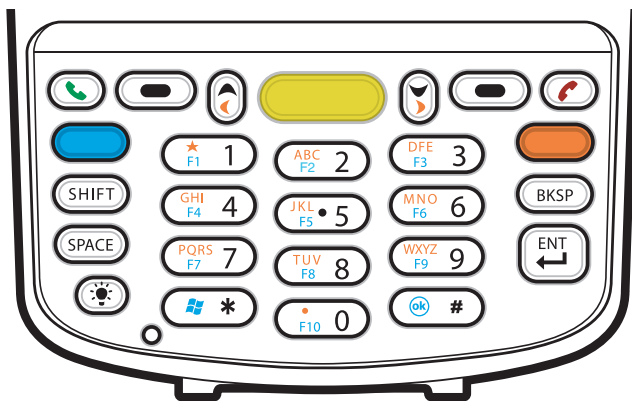

Figure B-1 MC75A Numeric Keypad

Table B-1 MC75A Numeric Keypad Descriptions













Key	Description
<p>Blue Key (left)</p> 	<p>Use this key to launch applications or access items (shown on the keypad in blue). Press the Blue key once to activate this mode, followed by another key.</p> <p>A single press displays the following icon at the bottom of the screen, until a second key is pressed: </p>
<p>Orange Key</p> 	<p>Use this key to access the secondary layer of characters and actions (shown on the keypad in orange). Press the Orange key once to lock the keypad into Alpha state. A single press displays the following icon at the bottom of the screen: </p> <p>Press the Orange key a second time to return to the normal state.</p> <p>Press the Orange key, then the Shift key to add a temporary shift (that applies only to the next key pressed) to the orange lock state. This displays the following icon at the bottom of the screen: </p>
<p>Talk/End</p>  	<p>Talk (Green Phone): press to display the phone keypad window or to dial a phone number (from the phone keypad window).</p> <p>End (Red Phone): press when the phone keypad window displays to stop dialing or end a call.</p>
<p>Scan (yellow)</p> 	<p>Activates the scanner/imager in a scan enabled application.</p>
<p>Scroll Up and Down</p> 	<p>Moves up one item.</p> <p>Moves left one item when pressed with the Orange key.</p>
<p>Scroll Left and Right</p> 	<p>Moves down one item.</p> <p>Moves right one item when pressed with the Orange key.</p>
<p>Soft Keys</p> 	<p>Accesses the command or menu above it on the screen.</p>
<p>Star</p> 	<p>Produces an asterisk in default state.</p> <p>Press and release the blue key, then press the Star key to open the <i>Start</i> menu.</p>

Table B-1 MC75A Numeric Keypad Descriptions (Continued)









Key	Description
Alphanumeric 	<p>In default state, produces the numeric value on the key.</p> <p>In Alpha state, produces the lower case alphabetic characters on the key. Each key press produces the next alphabetic character in sequence. For example, press and release the Orange key and then press the '4' key once to produce the letter 'g'; press and release the Orange key and then press the '4' key three times to produce the letter 'i'.</p> <p>Press the SHIFT key in Alpha state to produce the upper case alphabetic characters on the key. For example, press and release the Orange key, press and release the SHIFT key, and then press the '4' key once to produce the letter 'G'; press and release the Orange key, press and release the SHIFT key and then press the '4' key three times to produce the letter 'I'.</p>
SPACE 	Produces a space.
BACKSPACE 	Produces a backspace.
SHIFT 	<p>Press and release the SHIFT key to activate the keypad alternate SHIFT functions.</p> <p>A single press displays the following icon at the bottom of the screen, until a second key is pressed: </p> <p>Press the Orange key, then the Shift key to add a temporary shift (that applies only to the next key pressed) to the orange lock state. This displays the following icon at the bottom of the screen: </p>
ENT (Enter) 	Executes a selected item or function.
Pound 	<p>Produces a pound/number sign.</p> <p>Press and release the blue key, then press the Pound key to produce an OK.</p>

Table B-2 *Numeric Keypad Input Modes*

Key	Numeric Mode			Orange Key (Alpha Lowercase Mode)				Orange + Shift Keys (Alpha Uppercase Mode)			
		Blue+ Key	SHIFT + Key	1st Press	2nd Press	3rd Press	4th Press	1st Press	2nd Press	3rd Press	4th Press
1	1	F1	!	*	*	*	*	*	*	*	*
2	2	F2	@	a	b	c		A	B	C	
3	3	F3	#	d	e	f		D	E	F	
4	4	F4	\$	g	h	i		G	H	I	
5	5	F5	%	j	k	l		J	K	L	
6	6	F6	^	m	n	o		M	N	O	
7	7	F7	&	p	q	r	s	P	Q	R	S
8	8	F8	*	t	u	v		T	U	V	
9	9	F9	(w	x	y	z	W	X	Y	Z
0	0	F10)	.				>			
Up	Up	Up	Hilight Up	Left				Left			
Down	Down	Down	Hilight Down	Right				Right			
Enter	Action	Action	Action	Action				Action			

Note: An application can change the key functions. The keypad may not function exactly as described.

DSD Keypad Configuration

The DSD keypad contains application keys, scroll keys, and function keys. The keypad is color-coded to indicate the alternate function key (blue) values. Note that an application can change keypad functions so the MC75A's keypad may not function exactly as described. See [Table B-3](#) for key and button descriptions and [Table B-4 on page B-7](#) for the keypad's special functions.

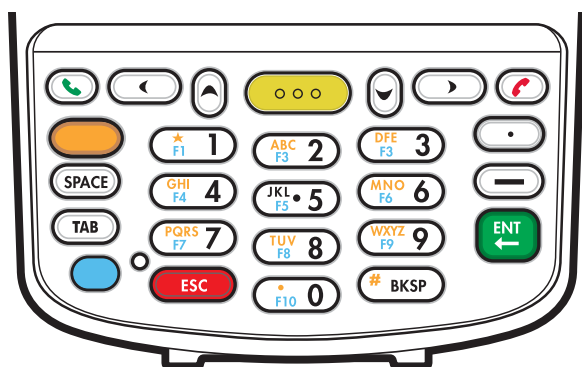

Figure B-2 MC75A DSD Keypad

Table B-3 MC75A DSD Keypad Descriptions







Key	Description
Blue Key (left) 	Use this key to launch applications or access items (shown on the keypad in blue). Press the Blue key once to activate this mode, followed by another key. A single press displays the following icon at the bottom of the screen, until a second key is pressed: 
Orange Key 	Use this key to access the secondary layer of characters and actions (shown on the keypad in orange). Press the Orange key once to lock the keypad into Alpha state. A single press displays the following icon at the bottom of the screen:  Press the Orange key a second time to return to the normal state. Press the Orange key, then the Shift key to add a temporary shift (that applies only to the next key pressed) to the orange lock state. This displays the following icon at the bottom of the screen: 
Talk/End  	Talk (Green Phone): press to display the phone keypad window or to dial a phone number (from the phone keypad window). End (Red Phone): press when the phone keypad window displays to stop dialing or end a call.
Scan (yellow) 	Activates the scanner/imager in a scan enabled application.

Table B-3 MC75A DSD Keypad Descriptions (Continued)







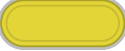







Key	Description
Scroll Up 	Moves up one item.
Scroll Left 	Moves left one item.
Scroll Down 	Moves down one item.
Scroll Right 	Moves right one item.
Alphanumeric    	<p>In default state, produces the numeric value on the key.</p> <p>In Alpha state, produces the lower case alphabetic characters on the key. Each key press produces the next alphabetic character in sequence. For example, press and release the Orange key and then press the '4' key once to produce the letter 'g'; press and release the Orange key and then press the '4' key three times to produce the letter 'i'.</p> <p>Press the SHIFT key in Alpha state to produce the upper case alphabetic characters on the key. For example, press and release the Orange key, press and release the SHIFT key, and then press the '4' key once to produce the letter 'G'; press and release the Orange key, press and release the SHIFT key and then press the '4' key three times to produce the letter 'I'.</p>
SPACE 	Produces a space.
BACKSPACE 	Produces a backspace.
ESC 	Cancels an operation or action.
ENT (Enter) 	Executes a selected item or function.
Period 	Produces a period character.
Dash 	Produces a dash character.

Table B-4 DSD Keypad Input Modes

Key	Numeric Mode			Orange Key (Alpha Lowercase Mode)				Orange + Shift Keys (Alpha Uppercase Mode)			
		Blue+ Key	SHIFT + Key	1st Press	2nd Press	3rd Press	4th Press	1st Press	2nd Press	3rd Press	4th Press
1	1	F1	!	*	*	*	*	*	*	*	*
2	2	F2	@	a	b	c		A	B	C	
3	3	F3	#	d	e	f		D	E	F	
4	4	F4	\$	g	h	i		G	H	I	
5	5	F5	%	j	k	l		J	K	L	
6	6	F6	^	m	n	o		M	N	O	
7	7	F7	&	p	q	r	s	P	Q	R	S
8	8	F8	*	t	u	v		T	U	V	
9	9	F9	(w	x	y	z	W	X	Y	Z
0	0	F10)	.				>			
.	.	.	.								
-	-	-	-								
Up	Up	Up	Hilight Up								
Down	Down	Down	Hilight Down								
Left	Left	Left	Hilight Left								
Right	Right	Right	Hilight Right								
Enter	Action	Action	Action	Action				Action			
ESC	ESC	ESC	ESC	ESC				ESC			

Note: An application can change the key functions. The keypad may not function exactly as described.

Alpha-numeric Keypad Configurations

The three types of alpha-numeric keypads produce the 26-character alphabet (A-Z, both lowercase and uppercase), numbers (0-9), and assorted characters. The keypad is color-coded to indicate which modifier key to press to produce a particular character or action. The keypad default is alphabetic, producing lowercase letters. See [Table B-5](#) for key and button descriptions and [Table B-6 on page B-11](#) for the keypad's special functions.



Figure B-3 QWERTY Keypad Configuration



Figure B-4 AZERTY Keypad Configuration

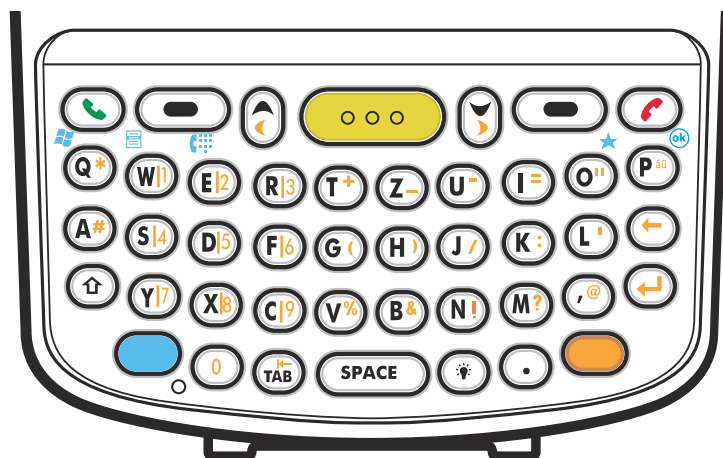

Figure B-5 QWERTZ Keypad Configuration

Table B-5 Alpha-numeric Keypad Descriptions









Key	Action
<p>Blue Key</p> 	<p>Launches applications (shown on the keypad in blue).</p> <p>Press the Blue key once to activate this mode temporarily, followed by another key. This displays the following icon at the bottom of the screen, until a second key is pressed: </p> <p>Press the Blue key twice to lock this mode. This displays the following icon at the bottom of the screen: </p> <p>Press the Blue key a third time to unlock.</p> <p>Press and hold the Blue key while selecting a sequence of keys to activate this mode temporarily. This displays the following icon at the bottom of the screen as long as the key is pressed: </p>
<p>Orange Key</p> 	<p>Accesses the secondary layer of characters and actions (shown on the keypad in orange).</p> <p>Press the Orange key once to activate this mode temporarily, followed by another key. This displays the following icon at the bottom of the screen, until a second key is pressed: </p> <p>Press the Orange key twice to lock this mode. This displays the following icon at the bottom of the screen: </p> <p>Press the Orange key a third time to unlock.</p> <p>Press and hold the Orange key while selecting a sequence of keys to activate this mode temporarily. This displays the following icon at the bottom of the screen as long as the key is pressed: </p>

Table B-5 Alpha-numeric Keypad Descriptions (Continued)















Key	Action
Talk/End  	Talk (Green Phone): press to display the phone keypad window or to dial a phone number (from the phone keypad window). End (Red Phone): press when the phone keypad window displays to stop dialing or end a call.
Scroll Up and Left 	Moves up one item. Moves left one item when pressed with the Orange key.
Scroll Down and Right 	Moves down one item. Moves right one item when pressed with the Orange key.
Soft Keys 	Accesses the command or menu above it on the screen.
Shift 	Changes the state of the alpha characters from lowercase to uppercase. <ul style="list-style-type: none"> • Press the Shift key to activate this mode temporarily, followed by another key. This displays the following icon at the bottom of the screen, until a second key is pressed:  • Press the Shift key twice to lock this mode. This displays the following icon at the bottom of the screen:  • Press the Shift key a third time to unlock.
Backlight 	Turns the display backlight on and off.
Backspace 	Produces a backspace.
Enter 	Executes a selected item or function.
Star  	Use this key in conjunction with the Blue key to produces an asterisk.
OK 	Use this key in conjunction with the Blue key as an OK or close button. This function is user programmable.

Table B-5 Alpha-numeric Keypad Descriptions (Continued)



Key	Action
Start Menu 	Use this key in conjunction with the Blue key to instantly display the <i>Start</i> menu from any application without tapping the screen. This function is user programmable.
Menu 	Use this key in conjunction with the Blue key to instantly display the context menu from any application without tapping the screen. This function is user programmable.
Phonepad 	Use this key in conjunction with the Blue key to display the Phonepad application without tapping the screen. This function is user programmable.

Table B-6 QWERTY Keypad Input Modes

Key	Normal	Shift + Key	Orange + Key	Blue + Key
Q	q	Q	*	Start Menu
W	w	W	1	Menu
E	e	E	2	Phone
R	r	R	3	
T	t	T	+	
Y	y	Y	-	
U	u	U	-	
I	i	I	=	
O	o	O	"	*
P	p	P	áü	OK
A	a	A	#	
S	s	S	4	
D	d	D	5	
F	f	F	6	
G	g	G	(
H	h	H)	
J	j	J	/	
K	k	K	:	

Note: An application can change the key functions. The keypad may not function exactly as described.

Table B-6 QWERTY Keypad Input Modes (Continued)

Key	Normal	Shift + Key	Orange + Key	Blue + Key
L	l	L	'	
Backspace	Backspace			
Shift	Shift			
Z	z	Z	7	
X	x	X	8	
C	c	C	9	
V	v	V	%	
B	b	B	&	
N	n	N	!	
M	m	M	?	
,	,	<	@	
ENTER	Enter			
0	0	0	0	0
TAB	Tab	Tab	Back tab	Tab
SPACE	Space	Space	Space	Space
Backlight	Backlight	Backlight	Backlight	Backlight
Star	*	*	*	*
.	.	>	.	.

Note: An application can change the key functions. The keypad may not function exactly as described.

Table B-7 AZERTY Keypad Input Modes

Key	Normal	Shift + Key	Orange + Key	Blue + Key
A	a	A	*	Start Menu
Z	z	Z	1	Menu
E	e	E	2	Phone
R	r	R	3	
T	t	T	+	
Y	y	Y	-	
U	u	U	-	

Note: An application can change the key functions. The keypad may not function exactly as described.

Table B-7 AZERTY Keypad Input Modes (Continued)

Key	Normal	Shift + Key	Orange + Key	Blue + Key
I	i	l	=	
O	o	O	“	*
P	p	P	áü	OK
Q	q	Q	#	
S	s	S	4	
D	d	D	5	
F	f	F	6	
G	g	G	(
H	h	H)	
J	j	J	/	
K	k	K	:	
L	l	L	‘	
M	m	M	?	
Shift	Shift			
W	w	W	7	
X	x	X	8	
C	c	C	9	
V	v	V	%	
B	b	B	&	
N	n	N	!	
,	,	<	@	
Backspace	backspace			
Enter	Enter			
0	0	0	0	0
TAB	Tab	Tab	Back tab	Tab
SPACE	Space	Space	Space	Space
Backlight	Backlight	Backlight	Backlight	Backlight
.	.	>	.	.

Note: An application can change the key functions. The keypad may not function exactly as described.

Table B-8 QWERTZ Keypad Input Modes

Key	Normal	Shift + Key	Orange + Key	Blue + Key
Q	q	Q	*	Start Menu
W	w	W	1	Menu
E	e	E	2	Phone
R	r	R	3	
T	t	T	+	
Z	z	Z	-	
U	u	U	-	
I	i	I	=	
O	o	O	"	*
P	p	P	áü	OK
A	a	A	#	
S	s	S	4	
D	d	D	5	
F	f	F	6	
G	g	G	(
H	h	H)	
J	j	J	/	
K	k	K	:	
L	l	L	'	
Backspace	Backspace			
Shift	Shift			
Y	y	Y	7	
X	x	X	8	
C	c	C	9	
V	v	V	%	
B	b	B	&	
N	n	N	!	
M	m	M	?	

Note: An application can change the key functions. The keypad may not function exactly as described.

Table B-8 QWERTZ Keypad Input Modes (Continued)

Key	Normal	Shift + Key	Orange + Key	Blue + Key
,	,	<	@	
ENTER	Enter			
0	0	0	0	0
TAB	Tab	Tab	Back tab	Tab
SPACE	Space	Space	Space	Space
Backlight	Backlight	Backlight	Backlight	Backlight
.	.	>	.	.

Note: An application can change the key functions. The keypad may not function exactly as described.

Special Character Key



NOTE Special characters are only available on the alpha-numeric keypad configurations.

To add special characters using the MC75A **áü** key, type the related character first, then press the Orange twice followed by the **áü (P)** key. Continue pressing the **áü** key until the special character displays. To modify an existing character, move the cursor to the right of the character then press the Orange key twice and then press the **áü** key until the special character replaces the original character. [Table B-9](#) lists the special characters you can generate.

Table B-9 Special Characters

Key	Special Characters	Key	Special Characters
a	à á â ã ä å æ	A	À Á Â Ã Ä Å Æ
c	ç ć Ć ©	C	Ç Ć Ć ©
d	ð	D	Ð
e	è é ê ë ě	E	È É Ê Ë Ě
i	ì í î ï	I	Ì Í Î Ï
l	ł	L	Ł ł
n	ñ	N	Ñ
o	ò ó ô õ ö ø œ	O	Ò Ó Ô Õ Ö Ø Œ
p	þ ƒ	P	þ ƒ
r	®	R	®
s	ş š ß	S	Ş Š ß
t	ţ	T	Ţ
u	ù ú û ü ú	U	Ù Ú Û Ü Ú

Table B-9 *Special Characters (Continued)*

Key	Special Characters		Key	Special Characters
y	ý		Y	Ý
z	ž ž		Z	Ž Ž
\$	€ £ ¥		/	\
"	' « ' »		([{ < «
)] } > »		+	± & - _
!	¡ ? ¿		.	: , ;
*	#		@	~ %
%	^		,	; : :
#	*		&	- _ + ±
_	+ ± & -		'	« » "
?	¿ ! ¡		:	: ; ,
-	_ + ± &			

Appendix C Voice Quality Manager

Introduction

The Voice Quality Manager (VQM) is a software package that resides on the MC75A. VQM enables a set of features for Voice over WiFi (VoWiFi) calls, and a sub-set of those features for cellular line (GSM or CDMA) calls. The VQM user interface is designed to be intuitive and easy to use, so complex tasks such as enabling the Acoustic Echo Canceller (AEC) while a call is in progress, automatically switching audio modality for VoWiFi calls, setting appropriate audio gains for VoWiFi, are done with very little or no user intervention.

Features

The VQM software:

- Improves the voice transmission quality without using additional battery power.
- Turns on the AEC for VoWiFi calls automatically, without user intervention.
- Automatically sets correct audio gains for VoWiFi calls, via specific profiles for VoWiFi and WAN calls.
- Capability to automatically switch audio mode to handset from speakerphone mode, after initiating a call or after accepting a call.
- Prioritizes the outgoing audio IP packets.
- Provides user-selectable audio modes (speakerphone and handset) with a single tap of the VQM icon. A VQM icon in the title bar of the device indicates the audio mode currently in use.
- NDIS 5.1 compliant.

Enabling VQM

To enable VQM:

1. Tap **Start** > **Programs** > **File Explorer**.
2. Navigate to the **Windows** folder.
3. Locate the file **VQMAudioNotify**.

4. Tap the filename to enable VQM.

Audio Modes

The MC75A can be in any one of the seven different audio modes. The mode is visually indicated by the VQM icon on the title bar.

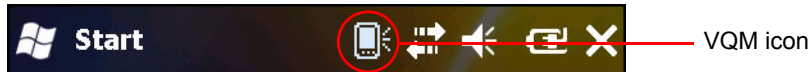

Figure C-1 VQM Icon in Title Bar

The VQM icon indicates that the device is in speakerphone mode without Acoustic Echo Cancellation (indicated by the gray VQM icon). The audio modes and their corresponding VQM title bar icons are:

Table C-1 VQM Icons

Icon	Description
	Speakerphone with Acoustic Echo Cancellation.
	Speakerphone without Acoustic Echo Cancellation.
	Handset with Acoustic Echo Cancellation (device can be transitioned to handset mode only while on a VoWiFi or WAN call).
	Headset while on a call (Acoustic Echo Cancellation is not enabled for wired or Bluetooth headsets).
	Headset while not on a call.
	Bluetooth headset while on a call (Acoustic Echo Cancellation is not enabled for wired or Bluetooth headsets). White icon.
	Bluetooth headset while not on a call. Gray icon.

Changing Audio Modes

Depending upon the audio mode being used, the mode can be changed by tapping the VQM icon in the title bar. The audio mode can only be changed while the user is on a call. VQM icon can be used to switch audio modes for WAN calls.

The table below lists the current audio mode and the subsequent audio mode after tapping the VQM icon.

Table C-2 *Changing Audio Modes*

Audio Mode before Tapping VQM Icon	Audio Mode after Tapping VQM Icon
Speakerphone	Handset
Handset	Speakerphone
Wired headset	Wired headset
Bluetooth headset	Reverts back to the last profile used before the Bluetooth connection.

If the audio mode is set to speakerphone and the user taps the VQM icon, the audio mode changes to handset.

When using a Bluetooth headset with BTE Explorer, enable the headset profile and ensure that the device is connectable. Pressing the headset button pairs the headset back to the MC75A. A second click of the headset button sends audio to the Bluetooth headset.

If the MC75A and the Bluetooth headset are un-paired, there is no way to go back to the Bluetooth headset using the VQM icon. The only way to reconnect the Bluetooth headset to the device is by using the BTE Explorer application.

If the user taps the VQM icon when a wired headset is connected to the MC75A, the audio mode does not change. The audio continues to get routed to the wired headset.

If the user taps the VQM icon while not on a call there is not change to the audio mode.

To view the VQM versions numbers tap **Start > File Manager**. Navigate to the **Windows** folder and search for VQMAudioNotify.exe file.

A dialog box displays listing the versions numbers.



Figure C-2 *VQM Audio Control Dialog Box*

Voice Packet Prioritization

IP soft phones transmit voice packets in the same manner as any other application that sends data over the network. On a network with different types of traffic, voice packets are given the same priority as any other traffic, and therefore may be subject to delays.

WiFi Multi-media (WMM) is a solution to this problem. WMM is a specification that supports prioritizing traffic, and “higher-priority” packets can be given preferential treatment.

To make use of WMM, the devices that generate traffic must mark their packets as high or normal priority in a field in the IP packet called Differentiated Services Code-Point (DSCP). The wireless infrastructure, which must be configured to support WMM, gives a higher priority to packets that have been marked as high priority through DSCP marking by the devices that generate traffic.

VQM detects if there is an ongoing Voice over WiFi (VoWiFi) call, and if so, marks outgoing voice packets (Only outgoing voice packets can be marked. The incoming voice packets have already been through the network, so it makes no sense to mark them.) as high-priority using DSCP. This enables WMM-compatible wireless infrastructure to treat the voice packets preferentially. This results in fewer delays for voice packets, which in turn improves the call quality.

Acoustic Echo Cancellation

Acoustic Echo occurs during a voice call when the audio from the earpiece enters the microphone of the same device. This results in the person at the other end hearing back a delayed version of his/her own voice (“Echo”). Needless to say, “Echo” is not desirable, and needs to be suppressed. This is the functionality performed by the Acoustic Echo Canceller (AEC). There are two approaches to suppressing the Echo:

- Turn the Acoustic Echo Canceller (AEC) on permanently. This approach is not very efficient because the device consumes more power when the AEC is on.
- Turn the Acoustic Echo Canceller (AEC) on only when there is an ongoing call.

VQM follows the second of the two approaches mentioned above.

VQM automatically turns on the Acoustic Echo Canceller (AEC) when the mobile device is in a VoWiFi call. When the call is terminated, VQM turns the AEC off. Note that the AEC is turned on for speakerphone and handset modes and does not get turned on for wired headset and Bluetooth headset modes. The AEC is not required for wired headset because the audio volume is quite low (because of the proximity of the earpiece to the ear), and therefore it is very unlikely for the audio from the earpiece to go in to the mouthpiece. Bluetooth headsets typically have an Echo Canceller built in. Turning the AEC on only while on a call saves battery power, compared to leaving the AEC turned on permanently.

The AEC is not turned on for Cellular calls because the WWAN phone application has a built-in echo canceller.

Limitations

- There is no VPN support in VQM.
- Only the Avaya softphone is supported.

Disabling VQM

To disable VQM perform a warm boot.

Glossary

A

API. An interface by means of which one software component communicates with or controls another. Usually used to refer to services provided by one software component to another, usually via software interrupts or function calls

Application Programming Interface. See **API**.

ASCII. American Standard Code for Information Interchange. A 7 bit-plus-parity code representing 128 letters, numerals, punctuation marks and control characters. It is a standard data transmission code in the U.S.

Autodiscrimination. The ability of an interface controller to determine the code type of a scanned bar code. After this determination is made, the information content is decoded.

B

Bar. The dark element in a printed bar code symbol.

Bar Code. A pattern of variable-width bars and spaces which represents numeric or alphanumeric data in machine-readable form. The general format of a bar code symbol consists of a leading margin, start character, data or message character, check character (if any), stop character, and trailing margin. Within this framework, each recognizable symbology uses its own unique format. See **Symbology**.

Bar Code Density. The number of characters represented per unit of measurement (e.g., characters per inch).

Bar Height. The dimension of a bar measured perpendicular to the bar width.

Bar Width. Thickness of a bar measured from the edge closest to the symbol start character to the trailing edge of the same bar.

Bit. Binary digit. One bit is the basic unit of binary information. Generally, eight consecutive bits compose one byte of data. The pattern of 0 and 1 values within the byte determines its meaning.

Bits per Second (bps). Bits transmitted or received.

boot or boot-up. The process a computer goes through when it starts. During boot-up, the computer can run self-diagnostic tests and configure hardware and software.

bps. See **Bits Per Second**.

Byte. On an addressable boundary, eight adjacent binary digits (0 and 1) combined in a pattern to represent a specific character or numeric value. Bits are numbered from the right, 0 through 7, with bit 0 the low-order bit. One byte in memory is used to store one ASCII character.

C

CDMA. Code Division Multiple Access (CDMA) is a form of multiplexing and a method of multiple access that does not divide up the channel by time (as in TDMA), or frequency (as in FDMA), but instead encodes data with a special code associated with each channel and uses the constructive interference properties of the special codes to perform the multiplexing.

CDRH. Center for Devices and Radiological Health. A federal agency responsible for regulating laser product safety. This agency specifies various laser operation classes based on power output during operation.

CDRH Class 1. This is the lowest power CDRH laser classification. This class is considered intrinsically safe, even if all laser output were directed into the eye's pupil. There are no special operating procedures for this class.

CDRH Class 2. No additional software mechanisms are needed to conform to this limit. Laser operation in this class poses no danger for unintentional direct human exposure.

Character. A pattern of bars and spaces which either directly represents data or indicates a control function, such as a number, letter, punctuation mark, or communications control contained in a message.

Character Set. Those characters available for encoding in a particular bar code symbology.

Check Digit. A digit used to verify a correct symbol decode. The scanner inserts the decoded data into an arithmetic formula and checks that the resulting number matches the encoded check digit. Check digits are required for UPC but are optional for other symbologies. Using check digits decreases the chance of substitution errors when a symbol is decoded.

Code Length. Number of data characters in a bar code between the start and stop characters, not including those characters.

Cold Boot. A cold boot restarts the mobile computer and erases all user stored records and entries.

COM port. Communication port; ports are identified by number, e.g., COM1, COM2.

Continuous Code. A bar code or symbol in which all spaces within the symbol are parts of characters. There are no intercharacter gaps in a continuous code. The absence of gaps allows for greater information density.

Cradle. A cradle is used for charging the terminal battery and for communicating with a host computer, and provides a storage place for the terminal when not in use.

D

Decode. To recognize a bar code symbology (e.g., UPC/EAN) and then analyze the content of the specific bar code scanned.

Decode Algorithm. A decoding scheme that converts pulse widths into data representation of the letters or numbers encoded within a bar code symbol.

Decryption. Decryption is the decoding and unscrambling of received encrypted data. Also see, **Encryption** and **Key**.

Depth of Field. The range between minimum and maximum distances at which a scanner can read a symbol with a certain minimum element width.

DRAM. Dynamic random access memory.

E

EMDK. Enterprise Mobility Developer's Kit.

Encoded Area. Total linear dimension occupied by all characters of a code pattern, including start/stop characters and data.

ENQ (RS-232). ENQ software handshaking is also supported for the data sent to the host.

ESD. Electro-Static Discharge

EvDO, 1xEV-DO. A wireless radio broadband data standard adopted by many CDMA mobile phone service providers. It is standardized by 3GPP2, as part of the CDMA2000 family of standards.

F

File Transfer Protocol (FTP). A TCP/IP application protocol governing file transfer via network or telephone lines. See **TCP/IP**.

Flash Disk. An additional megabyte of non-volatile memory for storing application and configuration files.

Flash Memory. Flash memory is nonvolatile, semi-permanent storage that can be electronically erased in the circuit and reprogrammed. Series 9000 mobile computers use Flash memory to store the operating system (ROM-DOS), the terminal emulators, and the Citrix ICA Client for DOS.

FTP. See **File Transfer Protocol**.

H

Hard Reset. See **Cold Boot**.

Hz. Hertz; A unit of frequency equal to one cycle per second.

Host Computer. A computer that serves other terminals in a network, providing such services as computation, database access, supervisory programs and network control.

High-Speed Downlink Packet Access (HSDPA). A 3G (third generation) mobile telephony communications protocol in the High-Speed Packet Access (HSPA) family, which allows networks based on Universal Mobile Telecommunications System (UMTS) to have higher data transfer speeds and capacity.

I

IDE. Intelligent drive electronics. Refers to the solid-state hard drive type.

IEC. International Electrotechnical Commission. This international agency regulates laser safety by specifying various laser operation classes based on power output during operation.

IEC (825) Class 1. This is the lowest power IEC laser classification. Conformity is ensured through a software restriction of 120 seconds of laser operation within any 1000 second window and an automatic laser shutdown if the scanner's oscillating mirror fails.

IEEE Address. See **MAC Address**.

Input/Output Ports. I/O ports are primarily dedicated to passing information into or out of the terminal's memory. Series 9000 mobile computers include Serial and USB ports.

Interleaved 2 of 5. A binary bar code symbology representing character pairs in groups of five bars and five interleaved spaces. Interleaving provides for greater information density. The location of wide elements (bar/spaces) within each group determines which characters are encoded. This continuous code type uses no intercharacter spaces. Only numeric (0 to 9) and START/STOP characters may be encoded.

Internet Protocol Address. See **IP**.

IP. Internet Protocol. The IP part of the TCP/IP communications protocol. IP implements the network layer (layer 3) of the protocol, which contains a network address and is used to route a message to a different network or subnetwork. IP accepts "packets" from the layer 4 transport protocol (TCP or UDP), adds its own header to it and delivers a "datagram" to the layer 2 data link protocol. It may also break the packet into fragments to support the maximum transmission unit (MTU) of the network.

IP Address. (Internet Protocol address) The address of a computer attached to an IP network. Every client and server station must have a unique IP address. A 32-bit address used by a computer on a IP network. Client workstations have either a permanent address or one that is dynamically assigned to them each session. IP addresses are written as four sets of numbers separated by periods; for example, 204.171.64.2.

IS-95. Interim Standard 95. The EIA/TIA standard that governs the operation of CDMA cellular service. Versions include IS-95A and IS-95B. See CDMA.

K

Key. A key is the specific code used by the algorithm to encrypt or decrypt the data. Also see, **Encryption** and **Decrypting**.

L

LASER. Light Amplification by Stimulated Emission of Radiation. The laser is an intense light source. Light from a laser is all the same frequency, unlike the output of an incandescent bulb. Laser light is typically coherent and has a high energy density.

Laser Diode. A gallium-arsenide semiconductor type of laser connected to a power source to generate a laser beam. This laser type is a compact source of coherent light.

laser scanner. A type of bar code reader that uses a beam of laser light.

LCD. See **Liquid Crystal Display**.

LED Indicator. A semiconductor diode (LED - Light Emitting Diode) used as an indicator, often in digital displays. The semiconductor uses applied voltage to produce light of a certain frequency determined by the semiconductor's particular chemical composition.

Light Emitting Diode. See **LED**.

Liquid Crystal Display (LCD). A display that uses liquid crystal sealed between two glass plates. The crystals are excited by precise electrical charges, causing them to reflect light outside according to their bias. They use little electricity and react relatively quickly. They require external light to reflect their information to the user.

M

MC. Mobile Computer.

MDN. Mobile Directory Number. The directory listing telephone number that is dialed (generally using POTS) to reach a mobile unit. The MDN is usually associated with a MIN in a cellular telephone -- in the US and Canada, the MDN and MIN are the same value for voice cellular users. International roaming considerations often result in the MDN being different from the MIN.

MIN. Mobile Identification Number. The unique account number associated with a cellular device. It is broadcast by the cellular device when accessing the cellular system.

Mobile Computer. In this text, *mobile computer* refers to the MC75A. It can be set up to run as a stand-alone device, or it can be set up to communicate with a network, using wireless radio technology.

N

Nominal. The exact (or ideal) intended value for a specified parameter. Tolerances are specified as positive and negative deviations from this value.

Nominal Size. Standard size for a bar code symbol. Most UPC/EAN codes are used over a range of magnifications (e.g., from 0.80 to 2.00 of nominal).

NVM. Non-Volatile Memory.

O

Open Data-Link Interface (ODI). Novell's driver specification for an interface between network hardware and higher-level protocols. It supports multiple protocols on a single NIC (Network Interface Controller). It is capable of understanding and translating any network information or request sent by any other ODI-compatible protocol into something a NetWare client can understand and process.

Open System Authentication. Open System authentication is a null authentication algorithm.

P

PAN . Personal area network. Using Bluetooth wireless technology, PANs enable devices to communicate wirelessly. Generally, a wireless PAN consists of a dynamic group of less than 255 devices that communicate within about a 33-foot range. Only devices within this limited area typically participate in the network.

Parameter. A variable that can have different values assigned to it.

PING. (Packet Internet Groper) An Internet utility used to determine whether a particular IP address is online. It is used to test and debug a network by sending out a packet and waiting for a response.

Print Contrast Signal (PCS). Measurement of the contrast (brightness difference) between the bars and spaces of a symbol. A minimum PCS value is needed for a bar code symbol to be scannable. $PCS = (RL - RD) / RL$, where RL is the reflectance factor of the background and RD the reflectance factor of the dark bars.

Q

Quiet Zone. A clear space, containing no dark marks, which precedes the start character of a bar code symbol and follows the stop character.

QWERTY. A standard keyboard commonly used on North American and some European PC keyboards. "QWERTY" refers to the arrangement of keys on the left side of the third row of keys.

R

RAM. Random Access Memory. Data in RAM can be accessed in random order, and quickly written and read.

Reflectance. Amount of light returned from an illuminated surface.

Resolution. The narrowest element dimension which is distinguished by a particular reading device or printed with a particular device or method.

RF. Radio Frequency.

ROM. Read-Only Memory. Data stored in ROM cannot be changed or removed.

Router. A device that connects networks and supports the required protocols for packet filtering. Routers are typically used to extend the range of cabling and to organize the topology of a network into subnets. See **Subnet**.

RS-232. An Electronic Industries Association (EIA) standard that defines the connector, connector pins, and signals used to transfer data serially from one device to another.

S

Scanner. An electronic device used to scan bar code symbols and produce a digitized pattern that corresponds to the bars and spaces of the symbol. Its three main components are: 1) Light source (laser or photoelectric cell) - illuminates a bar code;; 2) Photodetector - registers the difference in reflected light (more light reflected from spaces); 3) Signal conditioning circuit - transforms optical detector output into a digitized bar pattern.

Scanning Mode. The scanner is energized, programmed and ready to read a bar code.

Scanning Sequence. A method of programming or configuring parameters for a bar code reading system by scanning bar code menus.

Self-Checking Code. A symbology that uses a checking algorithm to detect encoding errors within the characters of a bar code symbol.

Shared Key. Shared Key authentication is an algorithm where both the AP and the MU share an authentication key.

SID. System Identification code. An identifier issued by the FCC for each market. It is also broadcast by the cellular carriers to allow cellular devices to distinguish between the home and roaming service.

Soft Reset. See **Warm Boot**.

Space. The lighter element of a bar code formed by the background between bars.

Specular Reflection. The mirror-like direct reflection of light from a surface, which can cause difficulty decoding a bar code.

Subnet. A subset of nodes on a network that are serviced by the same router. See **Router**.

Subnet Mask. A 32-bit number used to separate the network and host sections of an IP address. A custom subnet mask subdivides an IP network into smaller subsections. The mask is a binary pattern that is matched up with the IP address to turn part of the host ID address field into a field for subnets. Default is often 255.255.255.0.

Substrate. A foundation material on which a substance or image is placed.

Symbol. A scannable unit that encodes data within the conventions of a certain symbology, usually including start/stop characters, quiet zones, data characters and check characters.

Symbol Aspect Ratio. The ratio of symbol height to symbol width.

Symbol Height. The distance between the outside edges of the quiet zones of the first row and the last row.

Symbol Length. Length of symbol measured from the beginning of the quiet zone (margin) adjacent to the start character to the end of the quiet zone (margin) adjacent to a stop character.

Symbology. The structural rules and conventions for representing data within a particular bar code type (e.g. UPC/EAN, Code 39, PDF417, etc.).

T

TCP/IP. (Transmission Control Protocol/Internet Protocol) A communications protocol used to interconnect dissimilar systems. This standard is the protocol of the Internet and has become the global standard for communications. TCP provides transport functions, which ensures that the total amount of bytes sent is received correctly at the other end. UDP is an alternate transport that does not guarantee delivery. It is widely used for real-time voice and video transmissions where erroneous packets are not retransmitted. IP provides the routing mechanism. TCP/IP is a routable protocol, which means that all messages contain not only the address of the destination station, but the address of a destination network. This allows TCP/IP messages to be sent to multiple networks within an organization or around the world, hence its use in the worldwide Internet. Every client and server in a TCP/IP network requires an IP address, which is either permanently assigned or dynamically assigned at startup.

Telnet. A terminal emulation protocol commonly used on the Internet and TCP/IP-based networks. It allows a user at a terminal or computer to log onto a remote device and run a program.

Terminal. See **Mobile Computer**.

Terminal Emulation. A "terminal emulation" emulates a character-based mainframe session on a remote non-mainframe terminal, including all display features, commands and function keys. The VC5000 Series supports Terminal Emulations in 3270, 5250 and VT220.

TFTP. (Trivial File Transfer Protocol) A version of the TCP/IP FTP (File Transfer Protocol) protocol that has no directory or password capability. It is the protocol used for upgrading firmware, downloading software and remote booting of diskless devices.

Tolerance. Allowable deviation from the nominal bar or space width.

Transmission Control Protocol/Internet Protocol. See **TCP/IP**.

Trivial File Transfer Protocol. See **TFTP**.

U

UDP. User Datagram Protocol. A protocol within the IP protocol suite that is used in place of TCP when a reliable delivery is not required. For example, UDP is used for real-time audio and video traffic where lost packets are simply ignored, because there is no time to retransmit. If UDP is used and a reliable delivery is required, packet sequence checking and error notification must be written into the applications.

UPC. Universal Product Code. A relatively complex numeric symbology. Each character consists of two bars and two spaces, each of which is any of four widths. The standard symbology for retail food packages in the United States.

V

Visible Laser Diode (VLD). A solid state device which produces visible laser light.

W

Warm Boot. A warm boot restarts the mobile computer by closing all running programs. All data that is not saved to flash memory is lost.

Index

Numerics

- 1-D bar codes 3-1
- 2-D bar codes 3-2

A

accessories

- auto charge cable 7-1
- cables 7-2, 7-27
- charge cable 7-1
- communication/charge cables
 - battery charging 7-27
 - LED indicators 7-28
- DEX cable 7-1, 7-2
- EMDK 7-2
- four slot battery charger 7-1, 7-12
- four slot charge only cradle 7-7
- four slot Ethernet cradle 7-1, 7-3, 7-5
- headset 7-2, 7-26
- holster 7-2
- magnetic stripe reader 7-2, 7-14, 7-26
- microSD card 1-8
- modem cable 7-2
- modem dongle 7-2
- modem inverter cable 7-2
- MSR 7-2, 7-14
 - installation 7-14
 - magnetic stripe reading 7-14
- O'Neil printer cable 7-2
- serial charge cable 7-1
- SIM card 1-3
- single slot USB cradle 7-1
- single slot USB serial cradle 7-3
- spare battery 7-2
- specifications A-6
- stylus 7-2

- USB charge cable 7-1
- USB charger cable 7-2
- vehicle cradle 7-1, 7-9
- wall mounting kit, cradle 7-2
- Zebra printer cable 7-2
- zebra printer cable 7-2
- Acoustic Echo Cancellation C-2
- action button 2-21
- ActiveSync 2-8
 - icon 2-6
- adaptive frequency hopping 6-1
- adjusting handstrap 1-9
- adjusting volume 2-12
- AFH 6-1
- AirBEAM 2-8
- alpha-numeric keypad B-8
 - key descriptions B-9
- answering a call 4-7
- assisted GPS 5-2
- auto charge cable 7-1, 7-27
- AZERTY B-8

B

- backup battery
 - charging 1-5
- bar codes
 - one dimensional 3-1
 - two dimensional 3-2
- battery
 - charging 1-5, 7-3, 7-5, 7-7, 7-9, 7-12
 - check status 1-8
 - installing 1-4
 - removing 1-9
- battery charger
 - charging 7-12
 - charging indicators 7-13

- battery chargers
 - communication/charge cables 7-27
 - LED indicators 7-28
 - four slot 7-12
- battery charging 1-5
 - communication/charge cables 7-27
 - using four slot battery charger 7-12
 - using four slot Ethernet cradle 7-5, 7-7
 - using single slot USB serial cradle 7-3
 - using vehicle cradle 7-9
- battery icon 2-3, 2-13
- battery reserve options 2-13
- blue key B-2, B-5, B-9
- Bluetooth 6-1
 - adaptive frequency hopping 6-1
 - bonding 6-32
 - deleting bonded device 6-33
 - icon 2-6
 - security 6-2
 - turning off 6-5, 6-16
 - turning on 6-4, 6-16
- bluetooth
 - discovering devices 6-5, 6-17
 - icon 2-6
 - turning on and off 6-4, 6-16
- Bluetooth headset 4-4
- bonding
 - Bluetooth 6-32
- boot
 - cold 2-17, 6-3
 - warm 2-17, 6-4
- BTE Explorer 2-9
- bullets xv
- buttons
 - action 2-21
 - function 2-20
 - power 1-7, 2-17, 2-21
 - scan 2-21
 - up and down 2-21

C

- cables 7-2, 7-27
 - auto charge cable 7-1
 - charge only 7-1
 - connecting 7-27
 - DEX cable 7-1, 7-2
 - modem 7-2
 - modem dongle 7-2
 - modem inverter 7-2
 - serial charge 7-1
 - USB charge 7-1
 - USB charger 7-2
- calculator 2-8

- calendar 2-7
- calibrating the screen 1-7
- call history 4-10, 4-14
- camera xii
- charge only cable 7-1
- charging 2-15
 - spare batteries 1-7, 7-4, 7-10, 7-12
 - using four slot battery charger 7-12
 - using four slot Ethernet cradle 7-5, 7-7
 - using single slot USB serial cradle 7-3
 - using vehicle cradle 7-9
- charging indicators 7-28
 - four slot battery charger 7-13
 - four slot Ethernet cradle 7-5, 7-7
 - single slot USB serial cradle 7-4
 - vehicle cradle 7-11
- charging temperature 1-7, 7-4
- cleaning 8-1
- clock & alarms 2-10
- cold boot 2-17, 6-3
- command bar
 - icons 2-6
- communication 7-27
- communication/charge cables 7-27
 - battery charging 7-27
 - LED indicators 7-28
- conference call 4-19, 4-21
- configuration xii, 1-3
- Contacts 2-7
- contacts 2-7
- contacts application 4-5
- conventions
 - notational xv
- cradles
 - four slot battery charger 7-12
 - four slot charge only cradle 7-7
 - four slot Ethernet 7-1, 7-3, 7-5, 7-7
 - single slot USB serial 7-3
 - vehicle 7-1, 7-9

D

- data capture xii
 - imager operational modes
 - decode mode 3-3
 - image capture mode 3-3
 - pick list mode 3-3
 - imaging 3-2
 - linear scanning 3-1
 - one dimensional bar codes 3-1
 - scan angle 3-1
 - scan button 2-21
 - scan range 3-1
 - scanning 3-2, 3-3, 3-4

two dimensional bar codes 3-2
 deleting Bluetooth bond 6-33
 DEX cable 7-1, 7-2, 7-27
 display xii
 DSD keypad B-5
 key descriptions B-5
 dual line SIM 4-24

E

emergency calls 2-20, 4-7
 end key B-2, B-5, B-10
 entering data 2-22
 enterprise mobility developer kit 7-2
 ESD 1-8
 Ethernet cradle 7-1, 7-3, 7-5
 EVDO xii
 Evolution Data-Optimized 4-1

F

fabric holster 7-2
 file explorer 2-8
 flash card 7-26
 four slot battery charger 7-1, 7-12
 charging 7-12
 charging indicators 7-13
 four slot charge only cradle 7-7
 four slot Ethernet cradle 7-5
 charging 7-5, 7-7
 charging indicators 7-5, 7-7
 four slot spare battery charger
 setup 7-12
 shim installation 7-12
 function buttons 2-20

G

global positioning system 5-1
 GPS 5-1

H

handset C-2
 handset mode 4-3
 handstrap
 adjusting 1-9
 hard reset 2-17, 6-3
 headset 4-3, 4-4, 7-2, 7-26
 headset mode 4-3
 High-Speed Downlink Packet Access 4-1
 holster 7-2

I

icons
 ActiveSync 2-6
 battery 2-3, 2-13
 Bluetooth 2-6
 bluetooth 2-6
 speaker 2-12
 status 2-2
 task tray 2-6
 wireless status 2-6
 imager. See data capture, imaging, imagersample
 imaging 3-2
 indicators 2-15
 radio status 2-15
 information, service xvi
 installing battery 1-4
 Internet Explorer Mobile 2-7
 internet sharing 2-8
 IrDA 2-10

K

key descriptions
 alpha-numeric keypad B-9
 DSD keypad B-5
 numeric keypad B-2
 keypads xii
 DSD B-5
 input modes B-4, B-7, B-11, B-12, B-14
 key descriptions B-2, B-5, B-9
 numeric B-1
 phone 4-1
 QWERTY B-8
 special character key B-15
 types B-1

L

laser scanning
 See data capture 3-1
 LEDs
 battery status 2-16
 charging 2-16, 7-4, 7-5, 7-7, 7-11, 7-13, 7-28
 indicators 2-15
 scan and decode 2-16, 3-2, 3-3, 3-4, 3-5
 lithium-ion battery 1-2
 locking MC75A 2-18

M

magnetic stripe reader 7-2, 7-14, 7-26
 installation 7-14
 magnetic stripe reading 7-14

- main battery
 - charging 1-2, 1-5
 - installing 1-2
- maintenance 8-1
- Media Player 2-7
- memory xii
- memory card 1-8
- messaging 2-7
- mircoSD 1-8
- MMC 7-26
- modem cable 7-2, 7-27
- modem inverter cable 7-2
- MSP Agent 2-9
- MSR 7-2, 7-14, 7-26
 - installation 7-14
 - magnetic stripe reading 7-14
- muting a call 4-9

N

- navigation bar
 - icons 2-2
- notational conventions xv
- notes 2-8
- notes application 4-10
- numeric keypad B-1
 - input modes B-4, B-7
 - key descriptions B-2

O

- O'Neil printer cable 7-27
- operating environment A-1
- operating system xii
- orange key B-2, B-5, B-9

P

- passwords 2-19
 - hint 2-20
- phone 2-7
 - answering a call 4-7
 - call history 4-14
 - call swapping 4-17, 4-18
 - conference call 4-19, 4-21
 - contacts 4-5
 - keypad 4-1
 - muting a call 4-9
 - speed dial
 - adding entry 4-11
 - calling 4-6
 - deleting entry 4-13
 - editing entry 4-13
 - taking notes 4-10

- text messaging 4-21
- three-way call 4-19, 4-21
- turning on and off 4-2
- using keypad 4-5
- pictures 2-7
- power button 1-7, 2-17, 2-21

Q

- QWERTY keypad
 - input modes B-11, B-12, B-14
- QWERTZ B-8

R

- radios xii
- rapid deployment 2-9
- removing main battery 1-9
- reset 2-17
 - hard 2-17, 6-3
 - soft 2-17, 6-4
- resume 6-4
- rigid holster 7-2
- RS232 charge cable 7-27

S

- scan button 2-21
- scan key B-2, B-5
- scan/decode 2-15
- scanning
 - button 2-21
 - imaging 3-2
 - See data capture 3-1
- screen
 - calibration 1-7
- screen protector 8-2
- SDK
 - See EMDK 7-2
- security
 - Bluetooth 6-2
- serial charge cable 7-1, 7-27
- service information xvi
- settings 2-10
 - about 2-11
 - backlight 2-11
 - beam 2-10
 - buttons 2-11
 - certificates 2-11
 - connections 2-10
 - customer feedback 2-11
 - encryption 2-11
 - error reporting 2-11
 - input 2-11

- keylight 2-12
- lock 2-10
- memory 2-12
- owner information 2-11
- power 2-10
- regional settings 2-12
- remove programs 2-12
- screen 2-12
- sounds & notifications 2-10
- system info 2-12
- USB to PC 2-11
- Wi-Fi 2-11
- wireless manager 2-11
- shim installation 7-12
- SIM card
 - accessories 1-3
 - install 1-3
- SIM Toolkit 2-9
- single slot USB cradle 7-1
- single slot USB serial cradle 7-3
 - charging 7-3
 - charging indicators 7-4
- SiRF III 5-1
- smart dialing 4-8
- soft reset 2-17, 6-4
- spare battery 7-2
 - charging 1-7, 7-4, 7-10, 7-12
- spare battery charger
 - setup 7-12
- speaker icon 2-12
- speaker mode 4-3
- special character key B-15
- speed dial 4-6, 4-11
- starting the EDA 1-3, 1-7
- status icon 2-2
 - battery 2-3, 2-13
 - speaker 2-12
- strap 1-2
- stylus 1-2, 2-21, 7-2
- subscriber identification module 1-3
- suspend 2-21, 6-4
- synchronize with PC
 - using Bluetooth 6-12

T

- talk key B-2, B-5, B-10
- task tray icons 2-6
- tasks 2-8
- technical specifications A-1
 - accessories A-6
- temperature A-2
 - charging 1-7, 7-4
- temperature notification 2-14

- three-way call 4-19, 4-21
- Time To First Fix 5-2
- Today screen 2-1
- troubleshooting 8-5

U

- unpacking 1-2
- up and down button 2-21
- USB charge cable 7-1
- USB charger 7-2
- USB client charge cable 7-27
- using Bluetooth headset 4-4
- using stylus 2-21
- using wired headset 4-3

V

- vehicle cradle 7-1, 7-9
 - charging indicators 7-11
- videos 2-7
- Voice Quality Manager C-1
- VQM C-1
 - disabling C-4
 - enabling C-1

W

- wakeup conditions 2-18
- waking EDA 2-18
- wall mounting kit, cradle 7-2
- warm boot 2-17, 6-4
- Windows Live 2-8
- Windows Live Messenger 2-7
- wired headset 4-3
- Wireless 1-12, 4-2
- Wireless Manager 1-12, 4-2
- wireless manager 2-11
- wireless status 2-6
- WLAN 802.11a/b/g xii
- WPAN Bluetooth xii

Z

- Zebra printer cable 7-27



Zebra Technologies Corporation
Lincolnshire, IL U.S.A.
<http://www.zebra.com>

Zebra and the stylized Zebra head are trademarks of ZIH Corp., registered in many jurisdictions worldwide. All other trademarks are the property of their respective owners.

©2015 ZIH Corp and/or its affiliates. All rights reserved.